

LC/LD/LF
3500 RPM

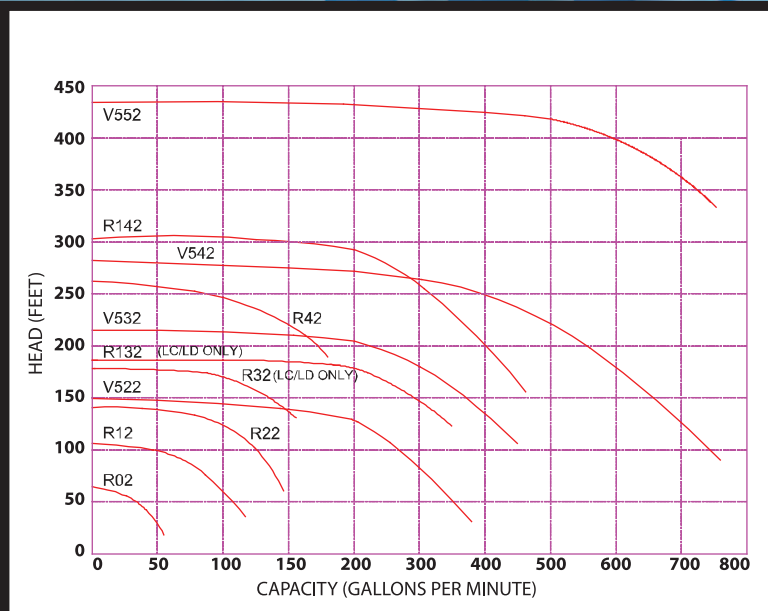

LC/LD/LF
1750 RPM

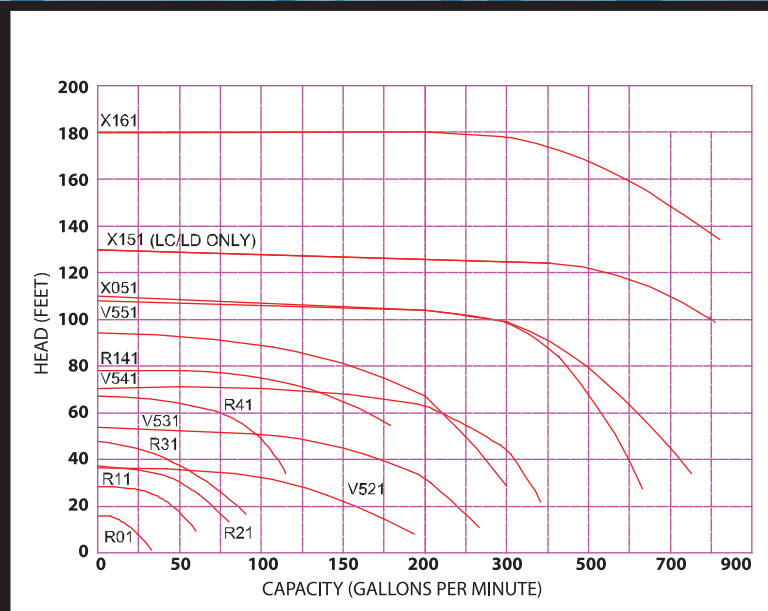

SP
1750 RPM

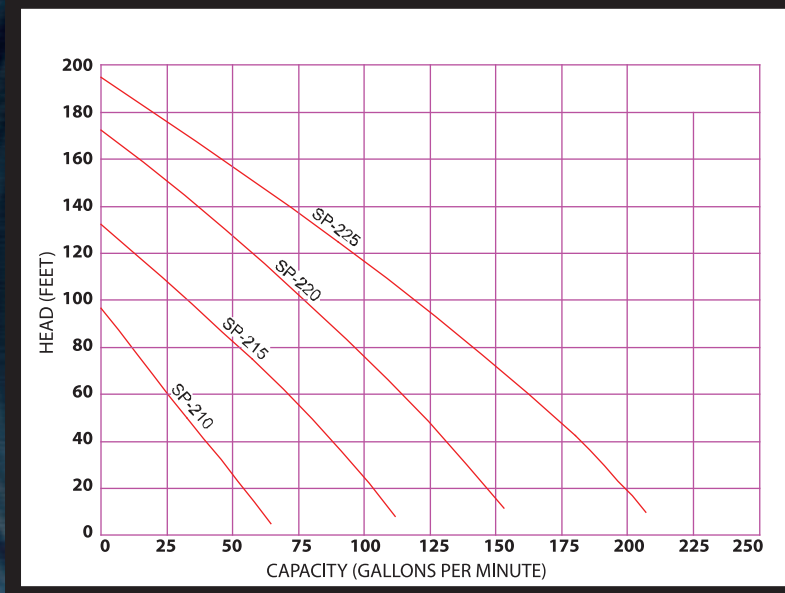

All assembled Ampco pumps are run on our test stand to verify hydraulic, mechanical and electrical performance prior to shipment.

Standard delivery is one week.

Please visit www.ampcopumps.com for individual pump curves and dimensional drawings.



Ampco Pumps Company, Inc • 2045 W. Mill Road, Glendale, WI 53209 • (414) 643-1852

Ampco Pumps Company



Ampco's NEW
LF Series

- With front loading seal design

LC/LD/LF/SP
SERIES PUMPS



LC/LD/LF Series

Ampco now offers three lines of high efficiency centrifugal pumps to meet all your sanitary requirements.

- New LF pumps offer a front loading seal design for ease of maintenance, and are easily convertible to a double seal without changing any other parts.

- High efficiency design and performance offers gentle product handling capability up to 1200 cps.
- Heavy-wall construction, tight manufacturing tolerances, dynamically balanced impellers and a self-aligning shaft minimize vibration and promote longer seal life.
- Standard adapters are made of 304 SS to resist corrosion.

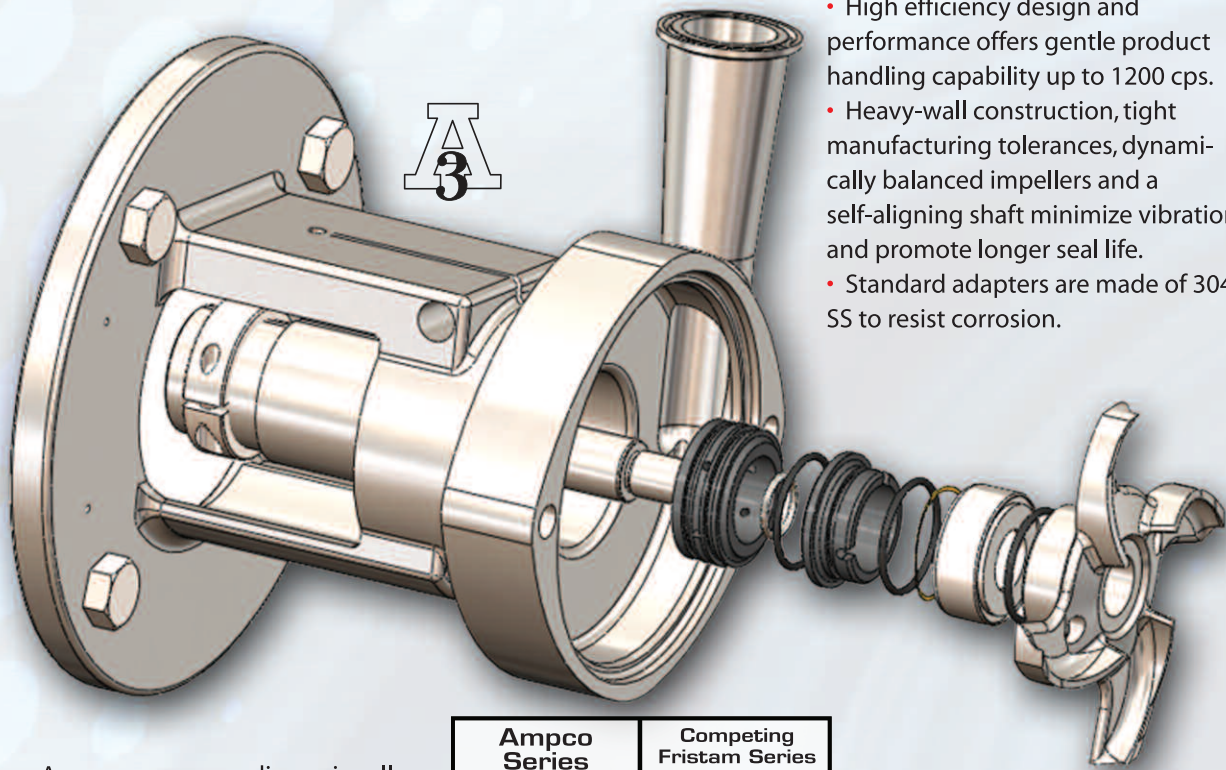

Ampco pumps are dimensionally and hydraulically interchangeable with competing brands.

Ampco Series	Competing Fristam Series
LC	FPX
LD	FP
LF	FPR
SP	FZX



TYPICAL APPLICATIONS

- **Beverages:** Fruit juices, fruit concentrate, mash, high fructose corn syrup, liquor, wine, beer, wort, yeast
- **Candy:** Corn syrup, chocolate, sugar solutions
- **CIP:** Caustics, enzyme cleaners, solutions
- **Cosmetics:** Lotions, soaps, shampoo
- **Dairy:** Cream, ice cream, buttermilk, milk, whey
- **Oils:** Salad, frying, cooking
- **Personal Care:** Cologne, mouthwash
- **Pharmaceuticals & Biotech**

SP Series

The self-priming capability of Ampco's SP liquid ring pumps make them ideally suited for CIP return applications and for handling products with entrained air.

- The ability to handle products with entrained air makes SP pumps extremely efficient for emptying tanks and drums.

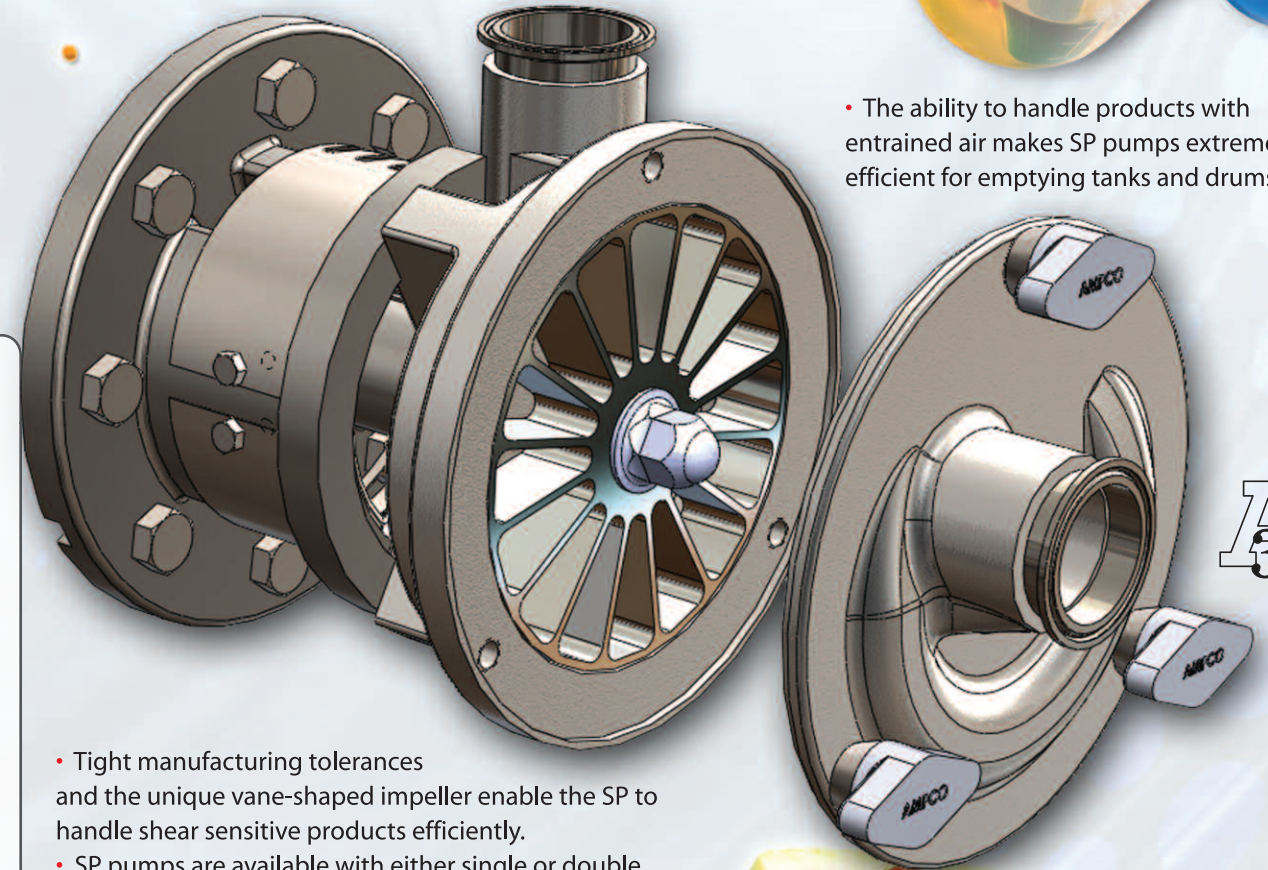

- Tight manufacturing tolerances and the unique vane-shaped impeller enable the SP to handle shear sensitive products efficiently.
- SP pumps are available with either single or double external mechanical seals.
- Standard adapters are made of 304 SS to resist corrosion.

STANDARD SEAL OPTIONS

LC SINGLE SEAL

- Standard Material:
- Silicon carbide / Carbon / Viton
 - Optional chrome oxide rotating element

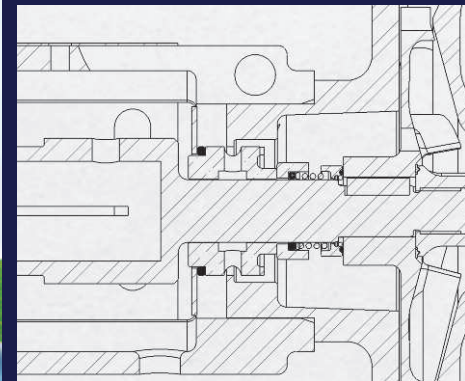

LD DOUBLE SEAL

- Standard Material:
- Silicon carbide / Carbon / Ceramic / Viton
 - Optional chrome oxide rotating element

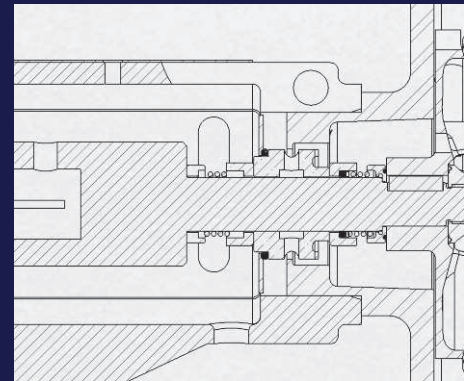

LF SINGLE SEAL

- Standard Material:
- Silicon carbide / Carbon / Viton
 - Optional double seal

