Instruction Manual



Anderson Instrument Co. Inc.
156 Auriesville Road
Fultonville, NY 12072
1-800-833-0081
Fax 518-922-8997

Instrument Model Number _____

Instrument Serial Number _____

"IZMSG"

Electromagnetic Flowmeter

Warranty

Anderson Instrument Company warrants to the original purchaser that equipment manufactured by Anderson Instrument is free from defects in material and workmanship for one (1) year from date of shipment. Anderson Instrument guarantees to repair or replace any of its equipment found defective, provided written notice of the defect is received within one year from date of shipment. Shipping charges to or from Anderson Instrument for new, replacement, or repaired equipment are not considered part of the warranty and remain the responsibility of the purchaser.

This warranty does not cover damages caused by ordinary wear and tear, erosion or corrosion, or misuse, abuse or improper handling. The warranty is void if a customer modifies or services the flowmeter physically or electronically in any way.

Anderson Instrument makes no additional warranties, expressed or implied, whether of merchantability or otherwise, other than that stated above. Anderson Instrument shall not be responsible beyond the remedy stated above for any indirect, special or consequential damages, or for any other claim arising out of the sale or use of its equipment.

Equipment, parts, or accessories manufactured by others carry the guarantee of the manufacturer only. Any warranties or claims which differ from the foregoing are unauthorized by Anderson Instrument and become the warranty solely of the party making them, unless specifically authorized in writing by an officer of Anderson Instrument Company

Should any provision of the foregoing be held ineffective, the remaining provisions shall continue in full force and effect.

Section 1

IZMSG Components

The Anderson Instrument IZMSG Compact Flowmeter is a precision instrument for sanitary volumetric measurement of electrically conductive fluids. The IZMSG flowmeter is designed to function within a wide range of operating conditions. It uses a measuring principle that eliminates moving parts or probes in the fluid flow which would contribute to fluid pressure losses.

The IZMSG flowmeter is engineered to provide maintenance-free operation. The non-obstructive design of the flow tube permits CIP (clean in place) and air blow or purge operation without damage to the flowmeter. See Appendix B, *Theory of Operation*, for an explanation of the measuring principle used in the IZMSG flowmeter.

The instructions in this document address the preparation, installation, and start-up of the IZMSG flowmeter meter body and converter as separate units. Information is provided on placing and mounting the meter body and converter, installing and connecting cabling, making electrical connections, commissioning the flowmeter, and conducting the hydraulic zero adjustment.

Unpacking

As you remove the system components from their boxes, inspect each piece. If anything looks damaged, or is missing, contact the shipping agent or Anderson Instrument Company, as appropriate.

The major items are:

- meter body with connection adapters assembled to the flow tube
- converter with plugs and polyethylene seal rings at all wire entry points
- cord grips and conduit adapters (separate bag)
- electrode signal cable (25-ft standard length)
- coil drive cable (25-ft standard length)

Meter body and converter are shipped as matched pairs with identical serial numbers. As you unpack the components, pair up each meter body with its matching converter and keep the matched pairs together during installation.

Meter Body

The meter body is diagrammed in Figure 1-1. The meter body housing has the flow tube through the center and the field terminal box on top. A pair of connection adapters is attached to each end of the flow tube with a connection gasket and held in place by bolts.

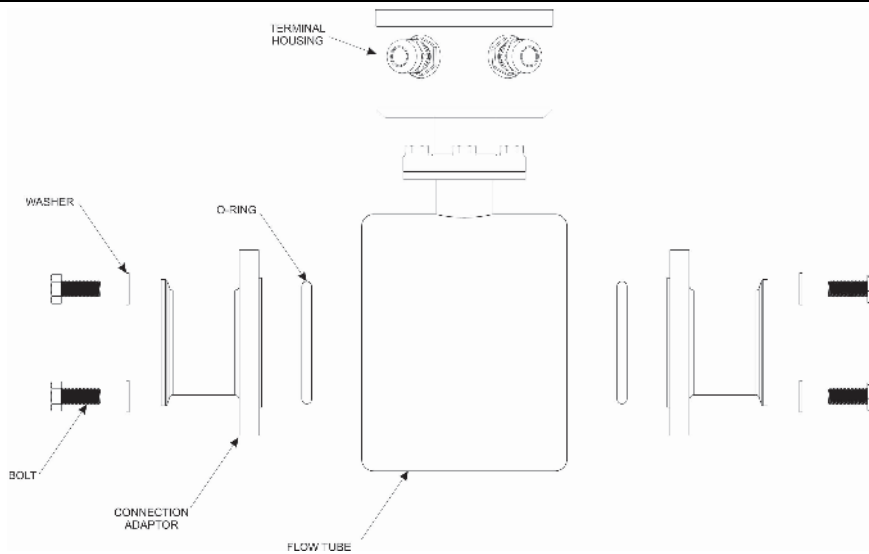

Figure 1-1. Meter Body Components

The meter body incorporates two electromagnetic coils and a PFA-lined flow tube in a stainless steel housing. Two electrodes are located inside the flow tube. The electrodes are centrally located in the flow tube and are diametrically opposed. The electrodes do not protrude into the flow tube and therefore will not disturb the fluid flow.

Converter

The microprocessor-based converter changes electrical signals from the meter body into flow rate and total data (see Figure 1-2). A coil drive circuit in the converter provides a switched and regulated constant coil current that excites a magnetic field

within the flow tube. The signal induced at the electrodes is amplified, digitized, and processed by the converter. The converter produces two separate frequency outputs and a 4 to 20mA analog output that are proportional to the flow rate.

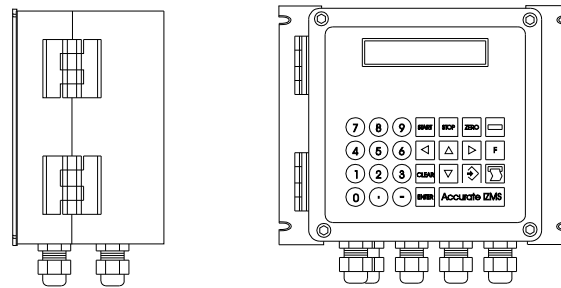

Figure 1-2. IZMSG Compact Converter
(side and front with display/keypad option)

Connection Cables

Anderson Instrument provides two shielded connection cables to connect the meter body with the converter. The customer must provide the AC supply voltage wiring and signal output cabling to peripheral devices. See Section 3, *Making Electrical Connections*, for drawings and additional information about the cables.

The Electrode Signal Cable is a 3-conductor cable with a shield wire. It is used to connect the electrodes in the meter body to the converter. The Coil Drive Cable is a 2-conductor cable with a shield wire. It is used to connect the coils in the meter body to the converter. Ferrules are attached on the ends of the wires of each cable to ensure proper connections to the terminals in the meter body and the converter.

Note: *The standard connection cable length is 25 feet. Longer connection cable length can be ordered from Anderson Instrument. Never splice cables together. If a connection cable shorter than 25 feet is required, it must be trimmed in the field (see Section 3, Making Electrical Connections).*

Circuit Boards

There are three circuit boards inside the converter: 300-SMB1 Main Board (Figure 1-3); 300-SACPSB AC Power Supply Board (Figure 1-4); and 300-SJB2 Junction Board (Figure 1-5). In a converter with the optional display and keypad, there is a fourth circuit board, 300-SDKB (Figure 1-6).

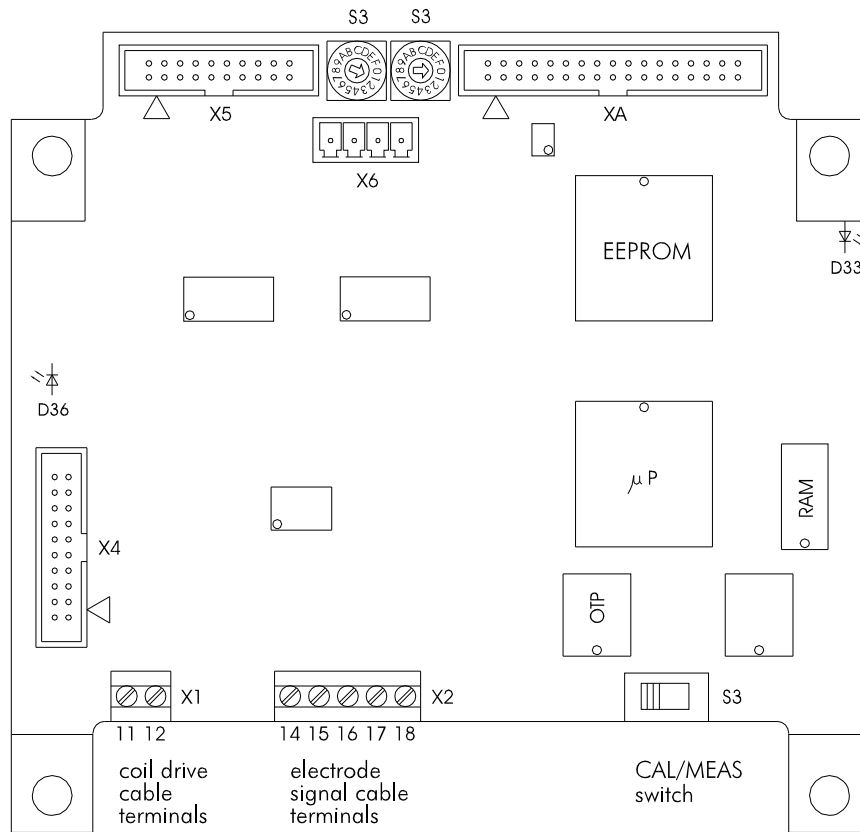

Figure 1-3. 300-SMB1 Main Circuit Board

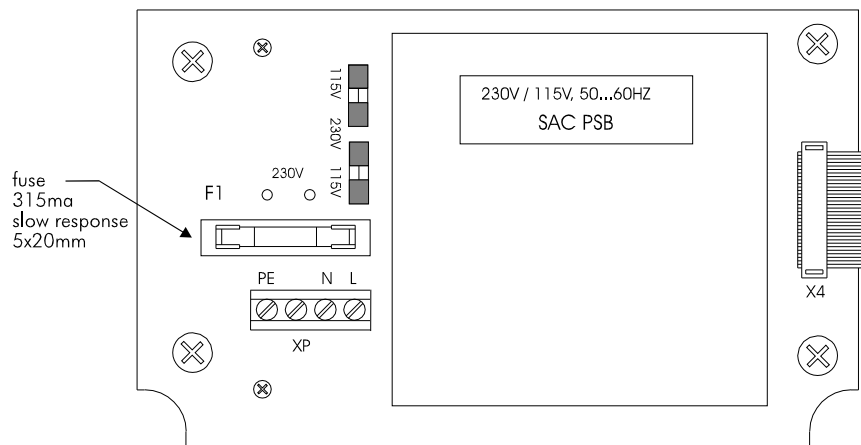

Figure 1-4. 300-SACPSB AC Power Supply Circuit Board

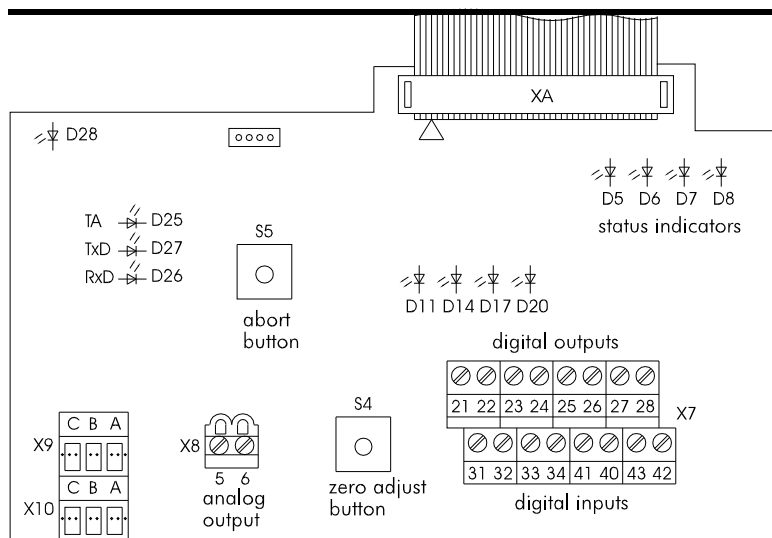

Figure 1-5. 300-SJB2 Junction Circuit Board

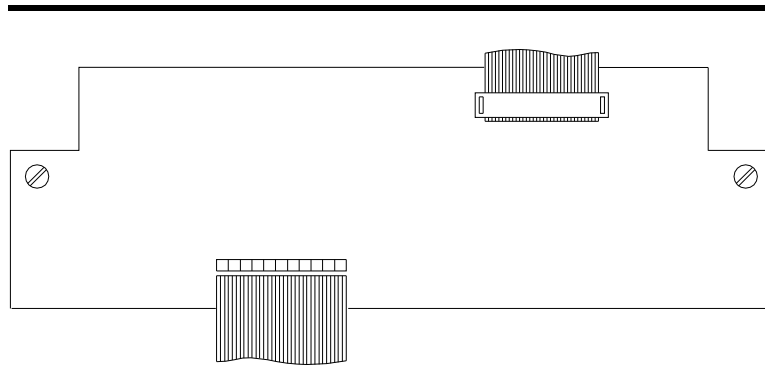

Figure 1-6. 300-SDKB Display and Keypad Circuit Board
(converter with LCD display)

Section 2

Installing the Meter Body and Converter

Meter Body

The meter body is shipped ready for installation in a matched pair with a converter. Verify that the converter serial number matches the meter body serial number.

The stainless steel connection adapters are factory assembled to the inlet and outlet sides of the meter body flow tube by bolts (see Figure 2-1). The connection adapters must always remain assembled to the meter body and should be removed for inspection purposes only. The adapters protect the ends of the PFA liner. The proper fit and seal is maintained between the connection adapters and the flow tube by o-ring connection gaskets.

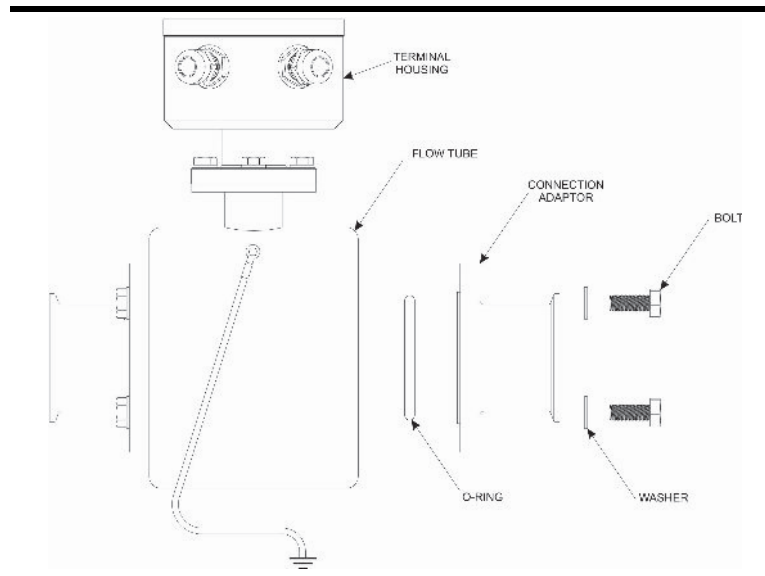

Figure 2-1. Meter Body Components

SPARE PARTS		
Part Number	Description	Quantity needed
45669A0015	EPDM connection seals 3/4"	2
45669A0025	EPDM connection seals 1"	2
45669A0032	EPDM connection seals 1.5"	2
45669A0050	EPDM connection seals 2"	2
45669A0065	EPDM connection seals 2.5"	2
45669A0080	EPDM connection seals 3"	2
45669A0100	EPDM connection seals 4"	2

Caution

Never install the meter body without a connection seal between the meter body flow tube and the connection adapter. Never substitute any other style of seal for the factory-supplied seals.

Location

The meter body provides Anderson measuring results when installed in either a vertical or horizontal pipe section. Select a location where the meter body will be completely filled with product. There must be a rise in the piping at the outlet side of the meter body. Avoid the presence of air, either bulk or entrained, from entering the product as it passes through the flow tube.

In a vertical pipe section, install the meter body in the upward direction of flow. In a horizontal pipe section, install the meter body at the lowest possible point of the piping system and position the meter body with the axis of the electrodes horizontal to the ground. This position will reduce sediment deposits and/or air bubbles on the electrode surface.

Precautions that must be followed when selecting a location for the meter body include:

- Do not install the meter body where the ambient temperature exceeds 130°F.
- Avoid installing the meter body next to equipment emitting strong electromagnetic fields that could distort the magnetic field generated by the flowmeter and cause measuring errors.
- Do not install the meter body where vacuum conditions may exist.

Guidelines for properly locating the meter body are summarized in the following table.

IZMSG INSTALLATION

Warning: • Before welding on a pipeline with a flowmeter installed, disconnect the signal electrode wires from the meter body at terminals 14, 16, and 18 at the converter.

• Make all converter connections prior to applying supply power.

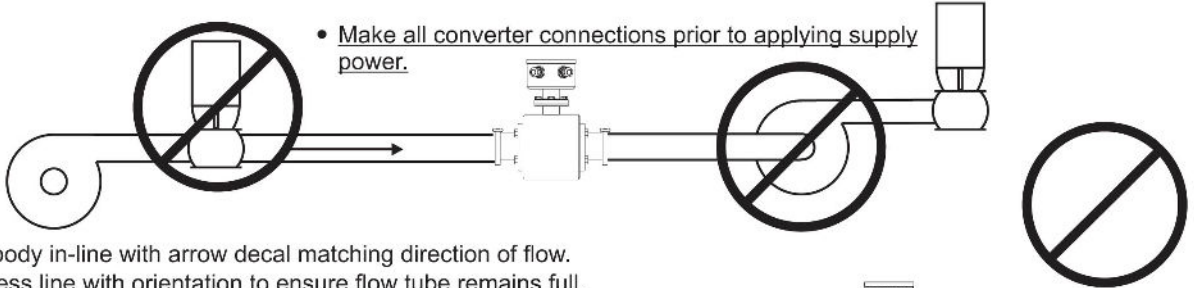

- Install meter body in-line with arrow decal matching direction of flow.
- Install in process line with orientation to ensure flow tube remains full.
- Do not install meter body where vacuum conditions may exist that could collapse the Teflon liner.
- Pipeline must be properly grounded, or earth ground can be landed to the flow tube lug.
- Avoid installing the meter body next to equipment emitting strong electromagnetic fields that could distort the magnetic field generated by the flowmeter and cause measuring errors.
- Never bundle or route either the electrode signal or the coil drive cable near any AC power line.
- Do not route electrode signal and coil drive cable through the same water tight connector at the meter body junction box.
- Make sure the meter body and the converter have identical serial numbers.
- For Cable Field Preparation see section 3, page 9 of the IZMSG Instruction Manual.
- Keep cable as short as possible. If needed, trim the cables to proper length at converter end of installation. See Page 3.

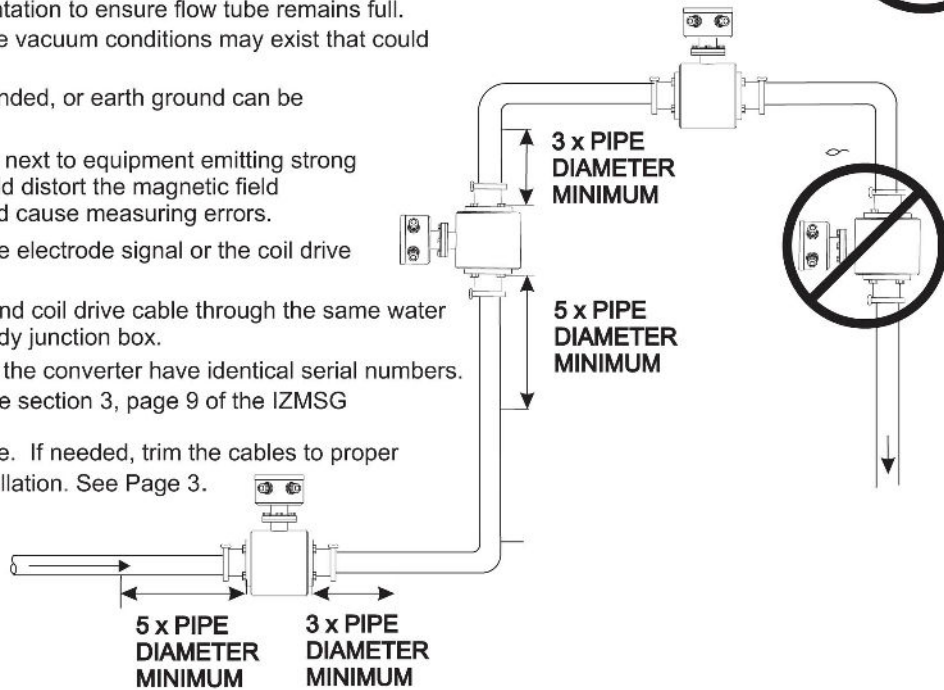

Installation Procedures

The meter body installation procedures must be tailored to the specific site and the size of the flowmeter. Select a location for the meter body using the guidelines discussed in the previous subsection.

Install the meter body with a minimum of 5 pipe diameters of straight, unobstructed pipe upstream from the meter body and 3 pipe diameters of straight, unobstructed pipe downstream when measured from the inlet and outlet of the meter body. No tees, elbows, valves, check valves, or other devices that may cause turbulent flow can be within these lengths of straight pipe.

To install the meter body:

1. Make sure the pipe section selected for the meter body has the proper clearance and support for the meter body with connection adapters. See Figure 2-2 and the table below for meter body dimensions and weight.
2. Place the meter body in-line with the arrow on the meter name plate pointing in the direction of flow.
3. Clamp the meter body in the pipeline using standard connection gaskets and sanitary clamps provided by the customer.

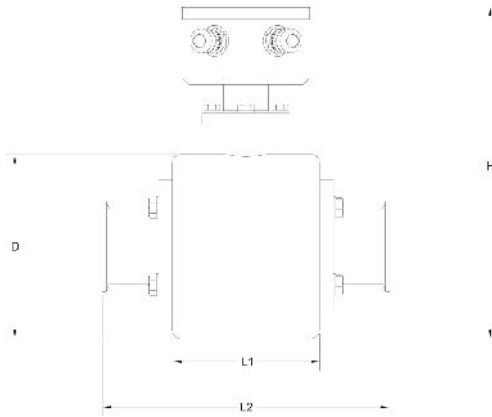

Figure 2-2. Meter Body Dimensions

Flowtube	D	H	L1	L2				Weight (lbs)
				Length Option				
				0	1	2	3	
3/4"	3.54"	8.86"	4.09"	8.00"	13.25"	9.88"	13"	11
1"	3.54"	8.86"	4.09"	8.00"	13.25"	9.88"	13"	11
1-1/2"	4.13"	9.45"	4.09"	8.00"	13.25"	9.88"	13"	11
2"	5.12"	10.43"	4.09"	8.00"	13.25"	9.88"	13"	17
2-1/2"	5.12"	10.43"	4.09"	9.00"	13.25"	9.88"	13"	17
3"	6.10"	11.42"	4.33"	9.88"	13.25"	9.88"	13"	26
4"	6.69"	12.01"	4.33"	9.88"	13.67"	9.88"	14"	34

Caution

Do not remove the meter body from the pipeline by disassembling the connection adapters from the meter body. Connection adapters should be disassembled and assembled to the meter body only after the meter body has been removed from the pipeline.

Converter

The converter is shipped ready for installation. Verify that the converter serial number matches the meter body serial number. The converter was factory flow tested and calibrated with the accompanying meter body as a matched set to the customer's specifications.

Caution

Never operate a meter body and converter with different serial numbers. The flowmeter will malfunction or operate improperly.

Location

Install the converter as close as possible to the meter body to avoid extraneous inductive pick-up. Do not substitute any other cable for a factory-supplied cable.

The standard factory-supplied cables are 25-feet long. If runs longer than 25 feet are required, contact Anderson Instrument Company. Do not splice cables. For runs shorter than 25 feet, the cable must be trimmed to the proper length. See Section 3, *Making Electrical Connections*, for instructions on field preparation of cables.

Precautions that must be followed when selecting a location for the converter include:

- Do not install the converter where the ambient temperature exceeds 130°F.
- Do not install the converter where it may be exposed to extreme vibration or direct sunlight.

-
-
- Do not install the converter near equipment emitting strong electromagnetic fields that could distort the signals generated by the flowmeter and cause measuring errors.
 - Do not mount the converter in a direct hose wash-down area where the unit may get wet or be exposed to cleaning compounds.

Installation Procedures

The converter installation procedures may need to be tailored to the specific site.

To install the converter:

1. Make sure the converter has the proper power supply voltage configuration for the specific installation. (See the information on power supply jumper configurations in Section 3, *Making Electrical Connections*.)
2. Make sure the converter has proper clearance to open the converter cover for installation and service (see Figure 2-3).
3. Close the cover of the converter. Tighten the screws on the front cover.
4. Mount the converter on the wall or panel using the mounting brackets.

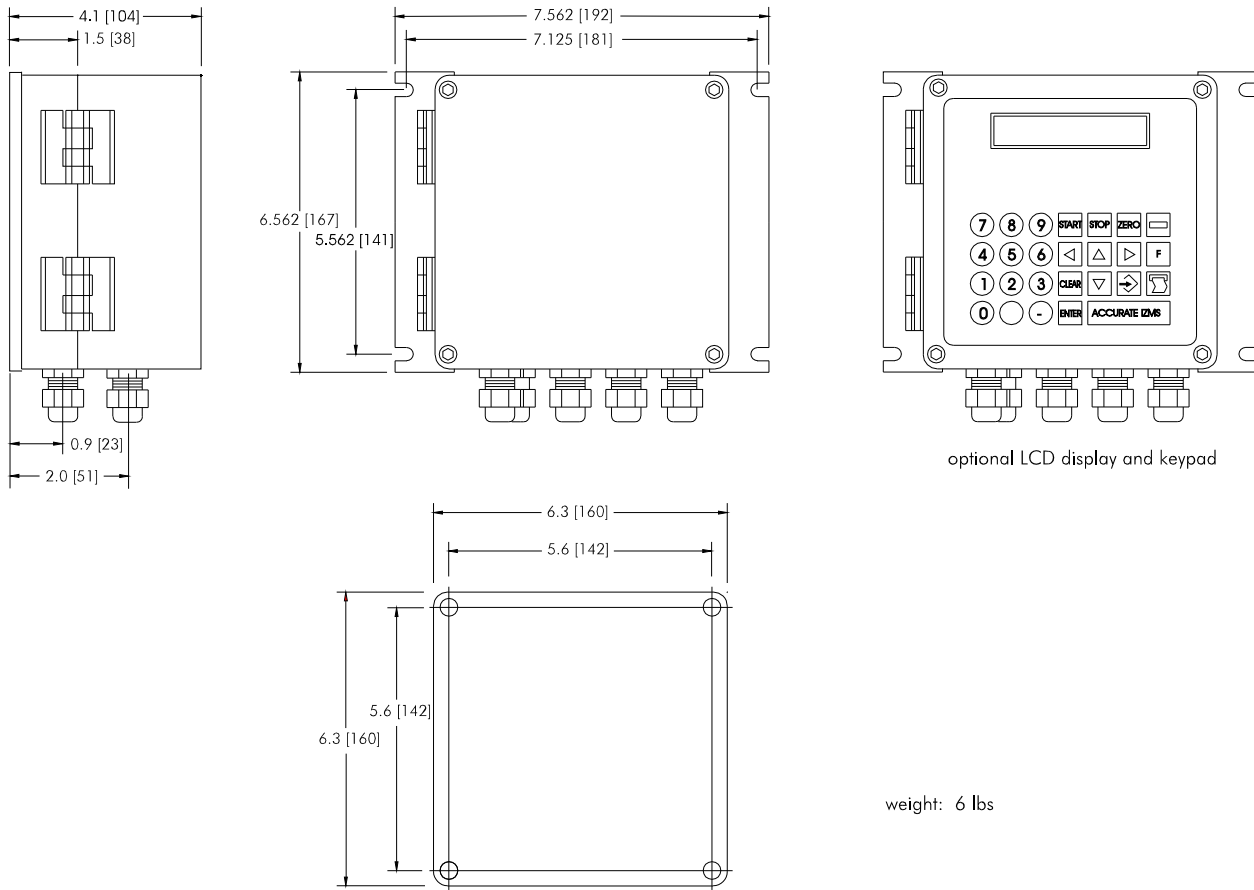

Figure 2-3. Converter Dimensions with/without Mounting Brackets

Section 3

Making Electrical Connections

Wire Openings and Connectors

Local code may require conduit for all or part of the wiring for the meter body and converter installation. However, whether conduit or direct cabling is used, the plugs on the meter body and converter must be removed and replaced with either cord grips or conduit adapters. See Figure 3-1 and following table for details.

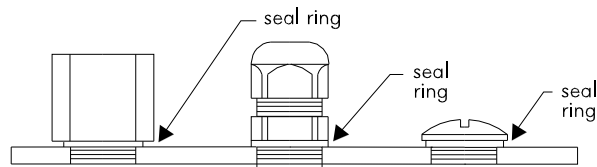

Figure 3-1. Conduit Adapter, Cord Grip, and Plug Wire Entry Hardware

Plug	Each IZMSG meter body and converter is shipped with plugs and seal rings at all entry points. When a plug is removed, transfer its seal ring to the corresponding cord grip or conduit adapter.
Cord Grip	When properly used, this connection offers high resistance to water intrusion by means of a sealing grommet which is compressed against the outer cable sheath. All connections must be tight and waterproof.
Conduit Adapter	This connection consists of a threaded adapter to mate directly with 1/2" NPT rigid conduit and liquid-tight conduit connectors. All connections must be tight and waterproof.

The recommended entry methods for cable or conduit are presented in Figure 3-2. Never enter the enclosure from the top or sides. Create a generous drip leg before each entry point to collect condensate from within the conduit or cable. After wiring, fill any void with an approved silicone sealant to ensure water tightness.

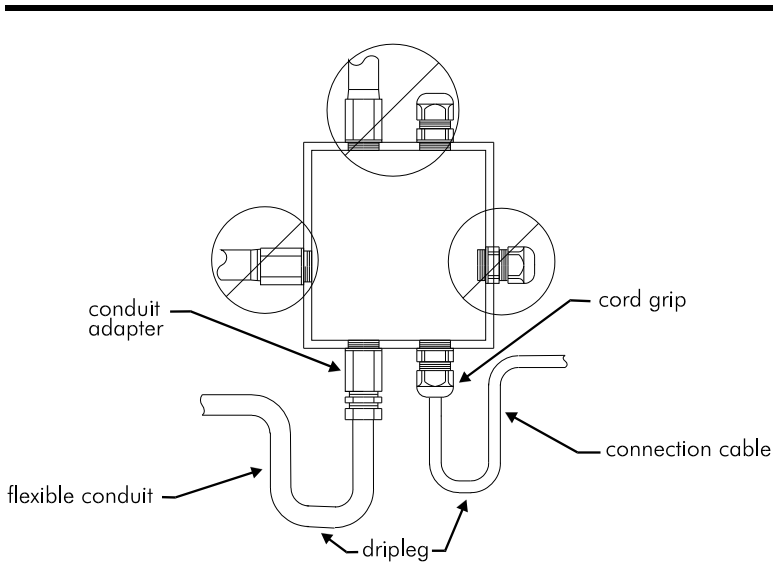

Figure 3-2. Recommended Cable and Conduit Entry Methods

Use only the designated openings in the converter for the input and output wiring (see Figure 3-3 for details). Do not substitute openings or create new openings.

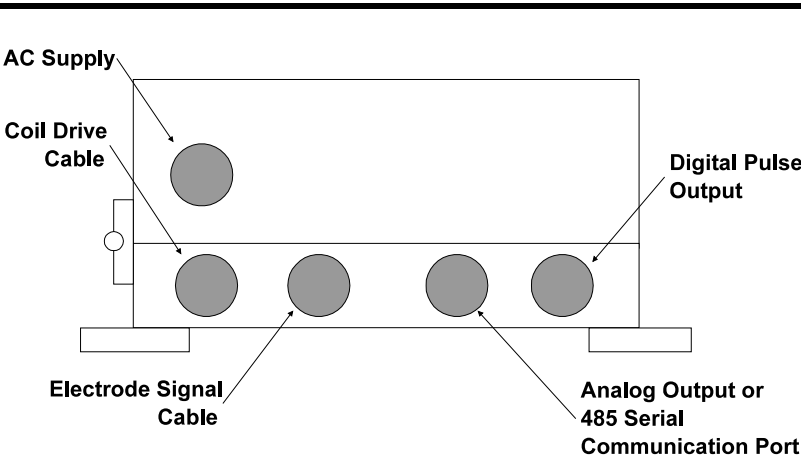

Figure 3-3. Converter Cable Openings

Grounding the Meter Body

The meter body must be properly grounded. The lack of an effective earth ground at the meter body will result in metering errors caused by extraneous voltage at the electrodes.

Anderson Instrument Company recommends attaching a dedicated wire from the 5mm (0.200") diameter ground lug on the side of the meter body to an effective earth ground connection point. The ground wire should be of sufficient wire gauge to provide zero resistance to the actual earth ground connection point.

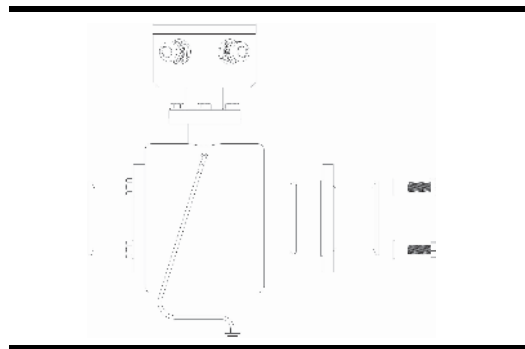

Figure 3-4. Meter Body Ground

Connection Cables

Anderson Instrument Company provides two factory-ready connection cables with the flowmeter. The electrode signal cable is a gray, 3-conductor shielded cable (see Figure 3-5). The coil drive cable is a black, 2-conductor shielded cable (see Figure 3-6).

Note: *Standard cable length is 25 feet. It is specially designed for the IZMSG Compact Flowmeter. The ends of the cable are prepared according to factory specifications. Never substitute any other cable for a factory-supplied cable. Do not splice connection cables. Contact the factory for cable length requirements that exceed 25 feet.*

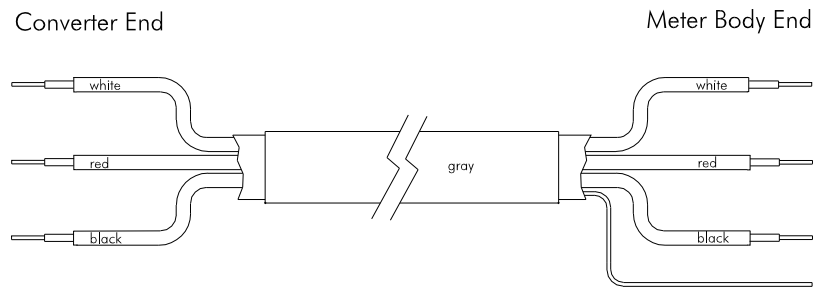

Figure 3-5. Electrode Signal Cable

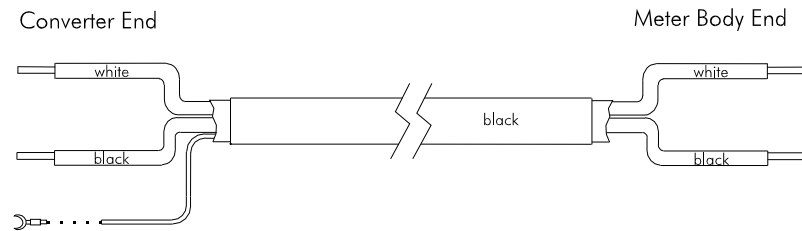

Figure 3-6. Coil Drive Cable

Connection cables can be routed through a rigid, dedicated conduit using water tight connectors at the meter body and converter enclosure. If desired, both cables may be routed in the same conduit. Separate the cables into two individual conduits adjacent to the meter body before routing the cables into the field terminal box on the meter body.

Caution

Never bundle or route either the electrode signal or the coil drive cable near any AC power line.

Connecting the Meter Body to the Converter

Caution

AC line power must be removed from the converter before the connection cables are installed or disconnected to avoid damaging the converter. If the connection cables are shorted together while power is applied to the converter, the coil drive power supply will be damaged.

Before making any connections:

- Make sure the meter body and the converter have identical serial numbers.
- Use only the factory-supplied connection cables.
- Keep the cable as short as possible. If needed, trim the cables to proper length at converter end of the installation. See the *Cable Field Preparation* in the following subsection.
- Use the proper cable openings in the converter for the connection cables. See *Wire Openings and Connectors* in the preceding subsection.

If conduit is used, the coil drive cable and electrode signal cable may be run in a common conduit. However, do not run cables with AC power lines. Exit the meter body through individual conduits and then join in an external junction box into a common dedicated conduit.

Before stringing or pulling connection cables, check the ends of the cables. Make sure the correct ends are at the meter body and converter. Start installing the connection cables at the meter body end first. Leave excess cable at the converter end of the run.

To install the connection cables at the meter body end:

1. String or pull gray electrode signal cable and the black coil drive cable from meter body terminal box to the converter. Pull the excess connection cable to the converter end of the cable run. Return to the meter body.

Note: The terminals in the meter body are spring compression terminals. To make the connection, insert a 1/8" (3mm) flat blade screwdriver into the opening on the top of the terminal. Press down on the screwdriver against the compression spring to open the terminal while pushing the ferrule on the end of each wire into the terminal opening. It is necessary to engage each wire of a multiwire cable slightly before working the wires into full engagement in the terminal.

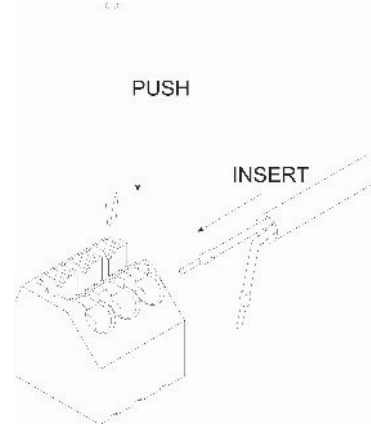

2. Connect the conductor wires to the terminal locations inside the meter body. See the following table.

Cable	Wire	Meter Body Terminal
Gray - Electrode Signal Cable	red	14
	white	16
	black	18
	shield	13
Black - Coil Drive Cable	white	11
	black	12

To install the connection cables at the converter end:

1. Carefully measure the amount of cable needed to enter the correct converter cable opening. Trim the excess length (see Cable Field Preparation in the next subsection)

Note: *Make sure the cable is routed through the proper wire opening. Use the correct wire entry hardware. See the preceding subsection for additional information on correct placement and use of wire entry hardware.*

2. Connect the conductor wires to the correct terminal location inside the converter. See the following table.

Cable	Wire	Converter Terminal
Gray - Electrode Signal Cable	red	14 on X2
	white	16 on X2
	black	18 on X2
Black - Coil Drive Cable	white	11 on X1
	black	12 on X1
	shield	see Steps 3 and 4

3. Attach a 1/4 inch crimp connector spade terminal to the coil drive cable shield wire.

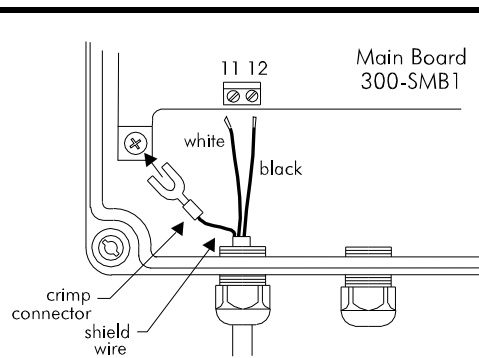

Figure 3-7. Coil Drive Cable Connections at Converter

4. Loosen Main Board attachment lug screw located in the lower left corner of the converter. Slide the spade terminal between the Main Board and underside of the head of the lug screw. Retighten the lug screw.

Caution

Before arc welding on a pipeline with a flowmeter installed, disconnect the electrode signal cable at terminals 13, 14, 16, and 18 at the meter body or terminals 14, 16, and 18 at the converter.

INTERNAL TERMINATIONS / ADJUSTMENTS

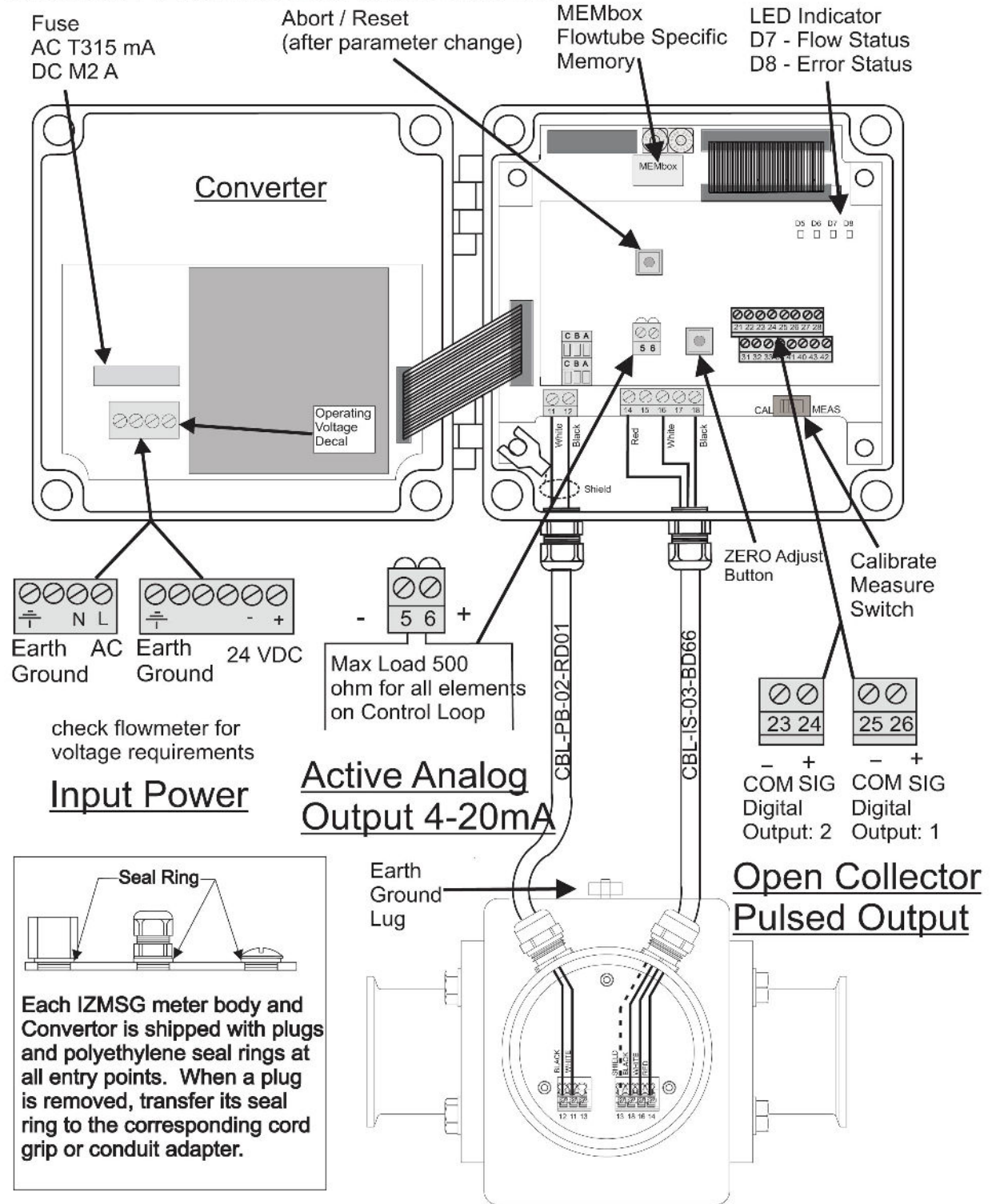

Figure 3-8. Meter Body-Converter Connections

Cable Field Preparation

Anderson Instrument Company provides two 25-ft long factory-prepared cables: Coil Drive and Electrode Signal. If either cable is too long, the excess cable must be trimmed at the converter end and the wires prepared for connection in the field. Procedures for adjusting the length of the cable follow.

Coil Drive Cable

The coil drive cable contains two conductors and a shield wire wrapped in an aluminum sheath. Make the adjustment to the length of this cable at the converter end of the cable.

1. Trim the factory prepared cable to the length of cable required. Discard the factory prepared end.
2. Remove 1.5" of external insulation and foil. Retain the shield wire.

Note: A factory-supplied 1/4" spade terminal will be crimped on to the shield wire after the cable has been fed into the converter.

3. Remove .25" of insulation from the black and white wires.

Electrode Signal Cable

The electrode signal cable contains three conductors and a shield wire wrapped in an aluminum sheath. Make the adjustment to the length of this cable at the converter end of the cable.

1. Trim the factory prepared cable to the length of cable required. Discard the factory prepared end.
2. Remove 1.5" of external insulation, fillers, and foil. Trim off the shield wire entirely.
3. Remove .25" of insulation from the black, white, and red wires.

AC Electrical Power Connections

To install the AC electrical power connections.

WARNING!

Do not apply electrical power to the converter until all wiring connections are completed and terminal locations verified.

1. Select a dedicated AC circuit for instrumentation. Do not select an AC electrical supply circuit that is used for powering large machines or motors.
2. Route the AC power supply wire through conduit in accordance with local regulations. Use a flexible whip of sufficient length to a fixed mounting point to allow the cover of the converter to be opened for service or inspection.
3. Open the cover of the converter to reveal the power supply on the inside lower portion of the cover.
4. Make sure the jumper configuration matches the supply voltage. Change the jumpers if required (see Figure 3-8).

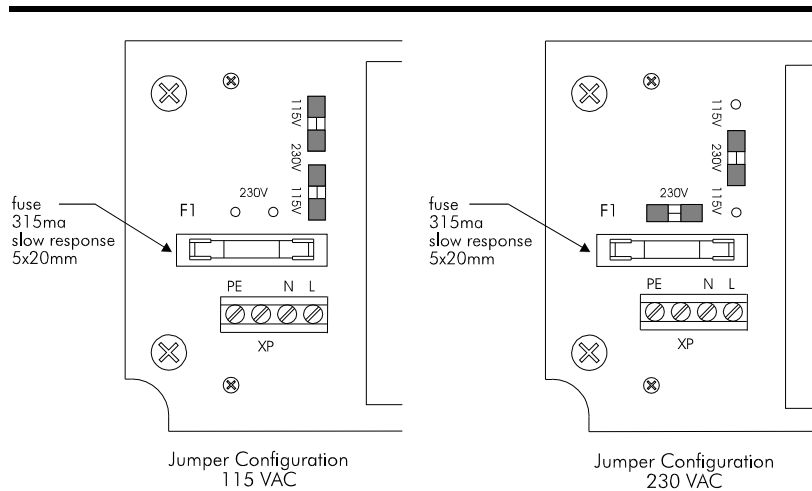

Figure 3-8. Power Supply Jumper Configuration

-
-
5. Route the AC power wires through the opening in the cover. Dress the AC wires between the inside of the cover skirt and the power supply circuit board.
 6. Connect the AC power supply wires to the correct location on terminal block XP: line to L and neutral to N.
 7. Connect an earth ground to the terminal block XP at the location marked PE. In most cases the green safety ground wire in 115 VAC, 3-wire service will provide a path to earth ground.

Caution

Failure to connect an earth ground to the terminal PE will cause the flow meter to malfunction.

8. Properly seal wire entry points in the converter enclosure and meter body to prevent moisture intrusion.

WARNING!

Keep the fuse cover in place to prevent exposure to electrical shock hazard. Disconnect AC power to the converter before making any wiring connections to the converter or meter body.

Signal Output Connections

All connections to external devices are made from terminal blocks in the converter on the 300-SJB2 Junction Board (see Figure 3-9 and table).

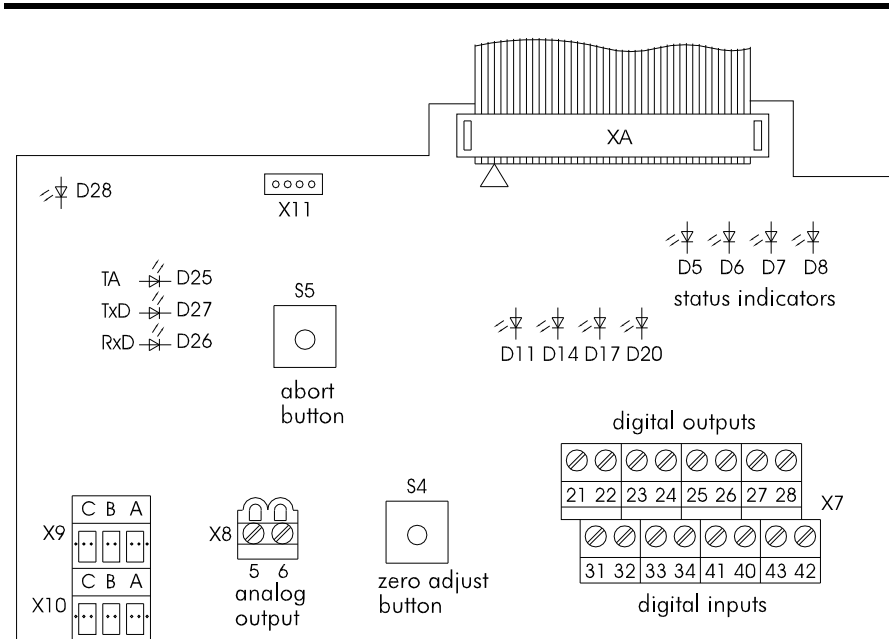

Figure 3-9. Converter 300-SJB2 Junction Board

300 SJB2 Board	Function
D5, D6, D7, D8	LED indicators for digital outputs
D11, D14, D17, D20	LED indicators for digital inputs
S5	ABORT pushbutton (reset)
S4	ZERO-ADJUST pushbutton
X7	digital output terminals 21-28 digital input terminals 31-34 and 41-43
X8	analog output terminals 5 and 6; 4-20 mA
X9, X10	485 serial interface
X11	plug for battery (option)
TA, TxD, RxD	LED indicators for 485 serial interface

Signal Output Descriptions and Terminal Numbers

There are four sets of signal output connections on the X7 digital output terminal block (see Figure 3-10). Pulse outputs IMP1 and IMP2 can be scaled independently of one another. IMP1 is the primary scaled pulse output. IMP2 is the secondary scaled pulse output. IMP3 provides an ON signal for flow in the forward direction, an OFF signal for flow in the reverse direction, and random FLASH under no flow conditions.

The maximum frequency signal output is 500 HZ. Signal configurations of 1000 HZ are available through Anderson Instrument as a special order. The open collector outputs are rated at 30 VDC maximum, 20 mA. Use a resistor to limit current in the digital output circuit to 20 mA. A typical resistor is 1.5K ohm, 1/8 watt at 12 VDC.

Analog output terminal X8 has two connectors, 5 (-) and 6 (+). The active analog output produces a 4 to 20 mA signal proportional to flowrate that will drive a control loop with a maximum load of 500 ohms (see Figure 3-10).

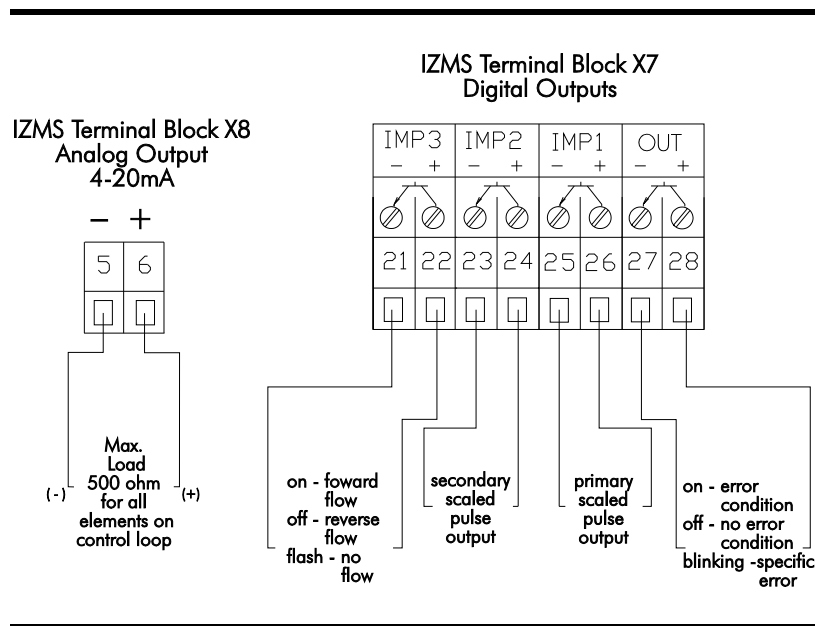

Figure 3-10. Typical Signal Outputs

Signal Wiring Configurations

Signal wiring configurations are provided for the following external output connections:

-
- Analog Output (Figure 3-18)
 - 24 VDC Pulse (Figure 3-19)

Signal wires to external receivers are not to be bundled or to share an electrical conduit with AC power wires. Use a separate conduit for all signal wires to prevent transient interference.

Section 4

Start-Up and Commissioning

Checking Flowmeter Configuration

All IZMSG Electromagnetic Flowmeters are flow tested and factory calibrated with water according to the flow conditions reported by the customer at the time of order. The factory pre-programs the calibration data unique to each flowmeter and the operational parameters necessary to meet the customer's specific application requirements. The pre-programmed data is retained in EEPROM memory in the converter. Therefore, the only on-site adjustment necessary will be the hydraulic zero adjustment.

The nameplate affixed to the converter provides information on the flowmeter configuration. Before operating the flowmeter, make sure that the serial number of the meter body matches the serial number on the converter. Attempting to operate an unmatched flowmeter pair will result in improper operation or malfunction.

Converter with LCD Display

When using a converter with an LCD display or a portable MSD Service Terminal, flowmeter parameters and other information such as the scaled digital pulse output, MAX flowrate, and calibration constants may be displayed and altered by means of the Menu Key. See Section 5, *Using the LCD Display*, for further information.

LED Indicators

There are four LED indicators located inside the converter in the upper right hand corner of the 300-SJB2 Junction Board (see Figure 3-9 in Section 3). The indicators are numbered D5, D6, D7, and D8. They serve as status indicators for digital outputs on terminal block X7. These visual status indicators are helpful during start up for diagnosing and resolving problems (see the following table).

LED No.	Digital Output Terminal	State	Indicating	Notes
D5	26 and 25	Off Flashing On	Indicates pause between pulses. Pulse output at IMP1. Pulse output at high frequency at IMP1.	During low flowrate conditions, the LED may flash so infrequently or briefly that the flash will not be visible.
D6	24 and 23	Off Flashing On	Indicates pause between pulses. Pulse output at IMP2. Pulse output at high frequency at IMP2.	During high flowrate conditions, the LED may flash so rapidly that the LED appears to be continuously on.
D7	22 and 21	Off Flashing at random frequency On	Reverse flow. No flow (after successful hydraulic zero procedure). Forward flow in direction of arrow.	Flow tube must be full of product.
D8	28 and 27	Off Flashing every half second Flashing every second On	No error condition exists. Unsuccessful hydraulic zero adjustment. No current in coil drive circuit to meter body. Error condition exists.	On converters without LCD display, an error condition automatically resets after 20 seconds as long as the error condition no longer exists.

Hydraulic Zero Adjustment

A hydraulic zero adjustment (Zero Adjust) must be performed in the field in order to adapt the flowmeter to the specific hydraulic conditions of the application. After a successful hydraulic zero adjustment has been accomplished, it will not be necessary to re-zero the flowmeter as long as the conditions of the installation remain unchanged.

Once initiated by the Zero Adjustment pushbutton, the hydraulic zero adjustment is done automatically within 40 seconds. During the adjustment period, do not work on the piping, wiring, meter body, or converter, since this will influence the hydraulic zero adjustment.

The Zero Adjustment pushbutton, S4, is located on the 300-SJB2 Junction Board between Terminals X7 and X8. The CAL/MEAS switch used during the hydraulic zero adjustment is located on the 300-SMB1 Main Board near the lower right corner. See Figure 4-1.

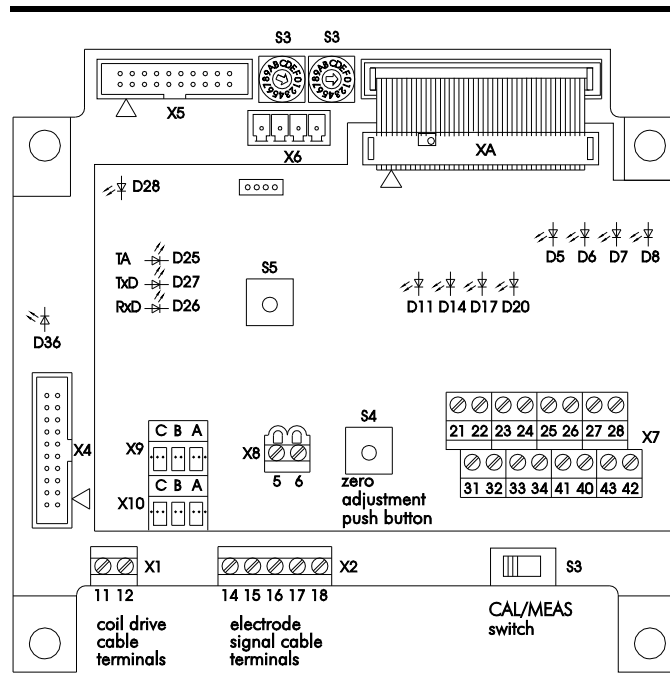

Figure 4-1. 300-SMB1 and 300-SJB2 Circuit Boards

Converter with LCD Display or Portable MSD Service Terminal

The procedure for hydraulic zero adjustment (Zero Adjust) for flowmeters with converters with LCD display or portable MSD service terminal is similar to flowmeters without LCD display. However, the LCD display and portable MSD service terminal provide additional visual feedback on the progress and satisfactory completion of the automatic zero measurement.

To conduct a hydraulic zero adjustment (Zero Adjust):

1. Make sure the wiring between the meter body and converter is set in the final fixed position. All wiring connections must be in proper terminal locations with tight and dry connections.
2. Allow 5 minutes for the flowmeter to warm up to operating temperature. In order to maintain thermal stability, close but do not tighten the converter cover during the hydraulic zero adjustment procedure, except when access to the converter is necessary to press buttons or observe the LED status.
3. Fill the flow tube of the meter body with liquid product or water. The electrical conductivity of the product must be greater than 100 micromhos. It is essential that the fluid remain static (no flow or leakage whatsoever) and there is no entrained air in the product during the hydraulic zero adjustment procedure.
4. Open the cover of the converter. Slide the CAL/MEAS switch on the Main Board to the left to the CAL position.
5. Press the Zero Adjustment pushbutton S4 on the Junction Board momentarily (about 2 seconds) and then release. The following visual display appears:

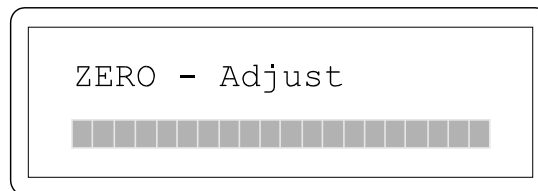

The cursor counts down right to left for 40 seconds showing the progress of the automatic zero measurement. At the end of the 40 second automatic

zero measurement period, the visual display shows the following:

ZERO - Adjust
ZERO xxx.xx

Where: XXX.XX is the new Zero Adjust value. The old Zero Adjust value is erased and the new Zero Adjust value is stored in the non-volatile memory of the converter.

Note: *After 5 seconds the display automatically reverts to the Measuring Register. Error message 3083 on the visual display indicates an unsuccessful hydraulic zero adjustment.*

6. *If there is an error message 3083, recheck all required conditions for the hydraulic zero adjustment procedure. Return to Step 5 and repeat the procedure.*
7. *Confirm the successful hydraulic zero adjustment by visually inspecting LED D7 and D8 on the Junction Board. Under no-flow conditions, LED 7 (forward flow) will be flashing on and off at a random frequency and LED D8 (error condition) will be off.*
8. *Slide the CAL/MEAS switch to the right to the MEAS position. The flowmeter is ready for normal operation.*

Note: *If error message 3083 remains on the visual display after repeating the hydraulic zero adjustment procedure, there may be a malfunction. Consult the factory for help with troubleshooting the problem.*

Zero Test

A separate function called Zero Test is available when using a converter with LCD display or portable MSD service terminal. A Zero Test is conducted under the same conditions as a Zero Adjust (full flow tube, no flow), but the zero value from a Zero Test is only displayed rather than stored. The Zero Test value is displayed for reference and comparison to the actual zero value stored in the non-volatile memory of the converter. After being displayed, the Zero Test value is discarded.

Caution

Do not perform a Zero Adjust when you only want to perform a Zero Test. The Zero Adjust procedure will cause a new zero value to be stored in the non-volatile memory of the converter thus changing the condition of the installation.

To a conduct a Zero Test:

- 1. Make sure the flow tube is full of product.*
- 2. Make sure there is no flow or leakage.*
- 3. Check all connection cables to make sure the terminations are tight and dry.*
- 4. Open the cover of the converter. The CAL/MEAS switch on the Main Board must be in the MEAS position.*

Note: *The position of the CAL/MEAS switch determines whether a Zero Test or Zero Adjust will be performed:*

<i>Position of CAL/MEAS Switch</i>	<i>Function Performed</i>
<i>MEAS</i>	<i>Zero Test</i>
<i>CAL</i>	<i>Zero Adjust</i>

- 5. Press the Zero Adjustment pushbutton S4 on the Junction Board momentarily (about 2 seconds) and then release.*

The visual display shows the following:

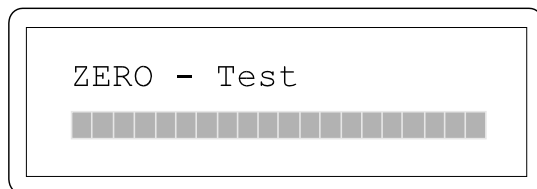

The cursor counts down right to left for 40 seconds showing the progress of the automatic zero measurement. At the end of the 40 second automatic zero measurement period, the visual display shows the following:

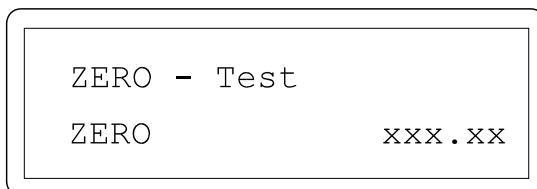

Where: XXX.XX is the zero measurement just completed. The Zero Test value is displayed for 5 seconds and then discarded. The display automatically reverts to the Measuring Register.

Function 00

A hydraulic zero adjustment (Zero Adjust) or a Zero Test can be conducted without access to the Zero Adjust pushbutton S4 on the Junction Board.

To conduct a Function 00 Zero Test:

- 1. Make sure the flow tube is full of product and there is no flow or leakage.*
- 2. Check all connection cables to make sure the terminations are tight and dry. The position of the CAL/MEAS switch on the Main Board determines whether a Zero Test or a Zero Adjust will be performed:*

Position of CAL/MEAS Switch	Function Performed
MEAS	Zero Test
CAL	Zero Adjust

Caution

Before executing a Function 00 procedure, check the position of the CAL/MEAS switch to avoid performing an undesired Zero Adjust.

- 3. Press key F. Then press key 0. Then press key 0.*

The display confirms the Zero-Adjust or Zero-Test according to the position of the CAL/MEAS switch. The cursor counts down right to left for 40 seconds showing the progress of the automatic zero measurement. At the end of the 40 second automatic zero measurement period, the visual display shows the zero value just measured. This display remains until any key is pressed. The display pauses four seconds and then reverts to the Measuring Register.

Always place the CAL/MEAS switch in the MEAS position during normal flowmeter measuring operations. Having the switch in the MEAS position prevents anyone from inadvertently changing the actual stored zero value and other critical calibration parameters.

Zero Test values can be useful for troubleshooting a flowmeter problem or revealing a hidden condition that may have an adverse effect on flowmeter performance. See Appendix A, Troubleshooting, for information on Repeating Zero Test Measurement and Comparing Zero Adjust and Zero Test Values.

Reversing Direction of Positive Flow Measurement

In certain installations it may be desirable to change the direction of positive flow measurement opposite to the forward flow arrow on the meter body nameplate.

To reverse the direction of positive flow measurement, exchange the location of the white and red wires on the electrode signal cable at terminal X2 on the converter. The white wire will now be in terminal 14 and the red wire will now be in terminal 16.

After changing the location of the white and red wires, it is necessary to conduct a new hydraulic zero adjustment (zero adjust) before resuming normal measuring operations.

Using the IZMSG Display Unit

Introduction

The optional LCD display and keypad are mounted on the converter enclosure cover. The display and keypad consist of a 2-line by 20-character backlit display and a 25-position membrane keypad.

During operation, the 2-line display always places the main totalizer V on the top line. The bottom line of the display can be toggled by the operator to display the secondary totalizer V2, grand totalizer SV, or the flowrate.

The top line of the display is also used to indicate error conditions. Refer to Appendix A, *Troubleshooting*, for Error Message Diagnosis.

Additionally, the display and keypad can be used to provide access to the flowmeter firmware for interrogation and modification of program parameters. This allows the flowmeter to be programmed in the field to meet the exact conditions of the measuring application or for fine tuning the flowmeter to the control requirements of the measuring system.

Using the IZMSG Display Unit

All IZMSG Electromagnetic Flowmeters are calibrated at the factory according to customer-specified parameters such as pulse output, flow range, etc. Parameters can be modified using the optional Integrated Display Unit (if purchased) or the portable, handheld Service Display Unit (MSD), sold separately.

The Integrated Display Unit and the Service Display Unit are identical in their function and use. However, the Service Display Unit is an external unit which must be plugged into the converter motherboard.

WARNING!

Never connect or disconnect the display unit via the connector X5 in the motherboard while the meter unit is powered on. The meter supply voltage must be disconnected first.

Portable MSD Service Display

The portable MSD Service Display can be temporarily connected to a converter that does not have an integral LCD display and keypad. The MSD Service Display, consisting of a display and keypad that is functionally identical to the converter LCD display and keypad, is packaged in a hand-held enclosure.

The MSD Service Display plugs directly into ribbon cable receptacle X5 on the 300-SMB1 Main Board.

Caution

Disconnect AC power to the converter before plugging in or removing the MSD Service Display from receptacle X5.

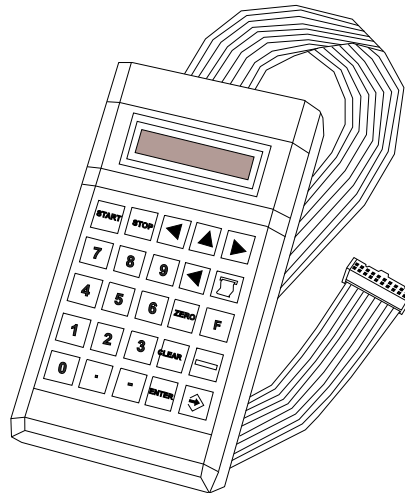



Figure 5-1. MSD Service Display

Parameter Organization

Parameters, process variables, and non-programmable data for review are organized into six groups called menus. Each menu can be called out and the parameters within that menu can be interrogated one by one by successive scrolling through the menu.

The menu key is identified by the key . Access to a specific menu is accomplished by pressing the menu key and two digits; for example: menu,0,2. The cursor keys can be used to move up and down a given menu or left and right to the neighboring menus on either side.

The default menu, designated by Menu 00, is the Measuring Register. The Measuring Register contains the display for the totalizers and the flowrate information. During normal operation the user should leave the display on the Measuring Register. Always return to the Measuring Register from other menus by pressing the menu,0,0 keys or by pressing the CLEAR key .

Parameter Map

The menu identification numbers and contents of each menu are organized according to the Parameter Map. By following the Parameter Map you can quickly access a parameter for interrogation or modification.

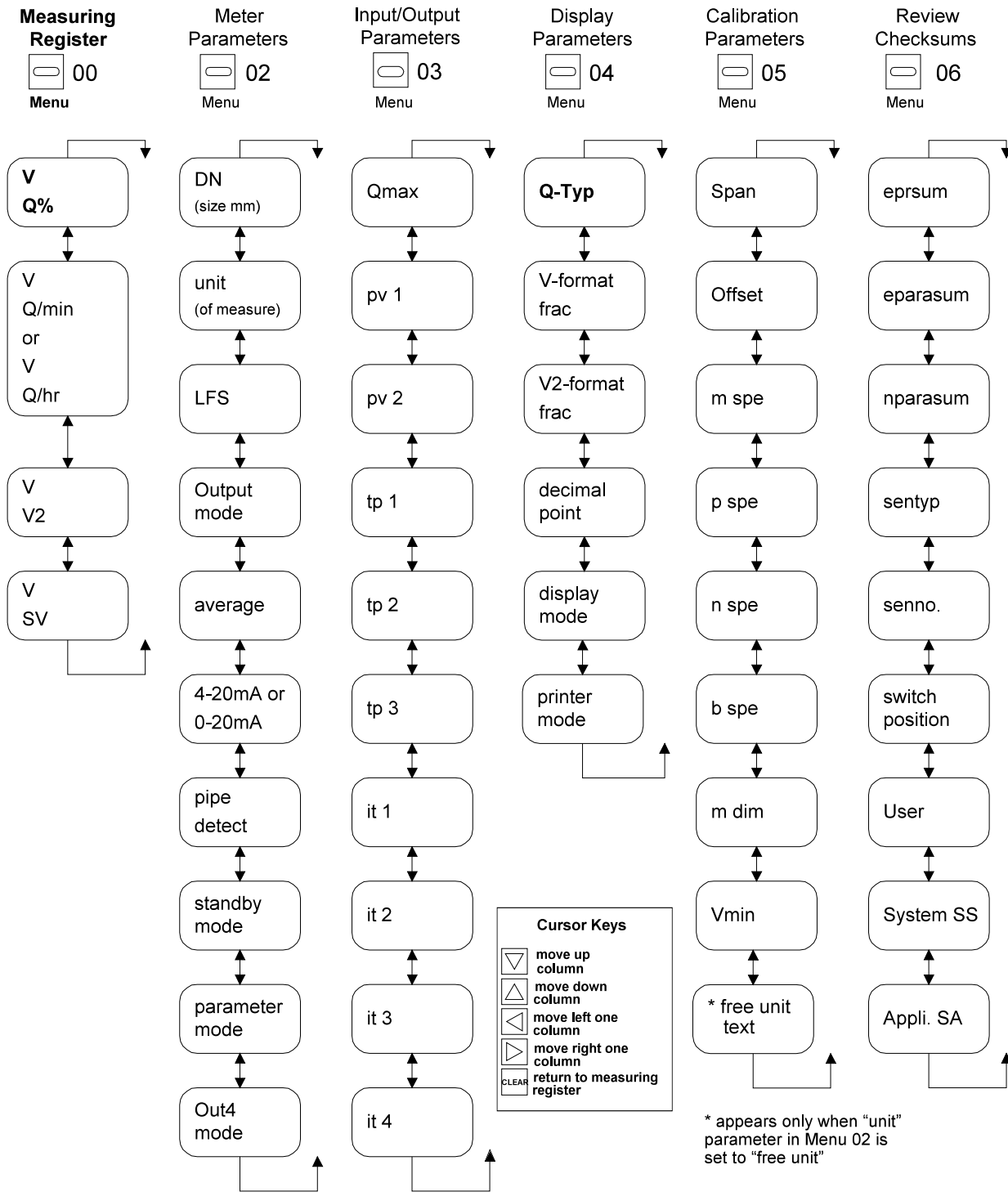

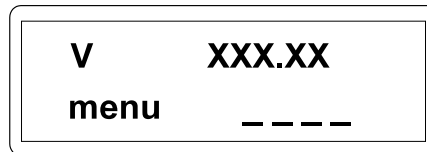







Figure 5-2. Parameter Map: IZMSG Compact Electromagnetic Flowmeter, User Software Version V1.XX

Changing Parameters Using the Display Unit

Parameters are classified by function and grouped into menus. They are accessed by entering the number of the menu to view. Individual menus are called using the keypad and the menu key . Table 5-1 lists the menu groups and the parameters in each menu.

- To view a parameter, press the  key. *You will see:*



- Use the keypad to enter the 2-digit menu number, for instance “02.”
- Parameter names and values appear in the bottom line of the display. To scroll through parameters in a menu, press the  or  keys. Table 5-1 lists the parameters in each menu.
- Parameters cannot be changed unless the CAL/MEAS switch is in the CAL position.
- The value of the current parameter can be changed by pressing the  key and then entering the desired value.
- Confirm the new value with the  key. *Note that the new value is accepted even if the  key is pressed.*

The meter body parameters—span, offset, and DN (size mm)—are stored in a removable EEPROM and should not be changed.

Note: The removable EEPROM must be plugged into connector X6 on the 300-SMB1 Main Board in the converter.

The meter body and converter are shipped from the factory as a matched pair with identical serial numbers. The EEPROM has been plugged into connector X6 on the converter motherboard and parameters specific to each application have been entered into the converter.

Caution

Never operate a meter body and converter with different serial numbers. The flowmeter will malfunction or operate improperly.

Should it become necessary to substitute a meter body or converter in the field and break-up a matched pair, consult the factory for the procedure for installing the EEPROM and reprogramming parameters in the converter.

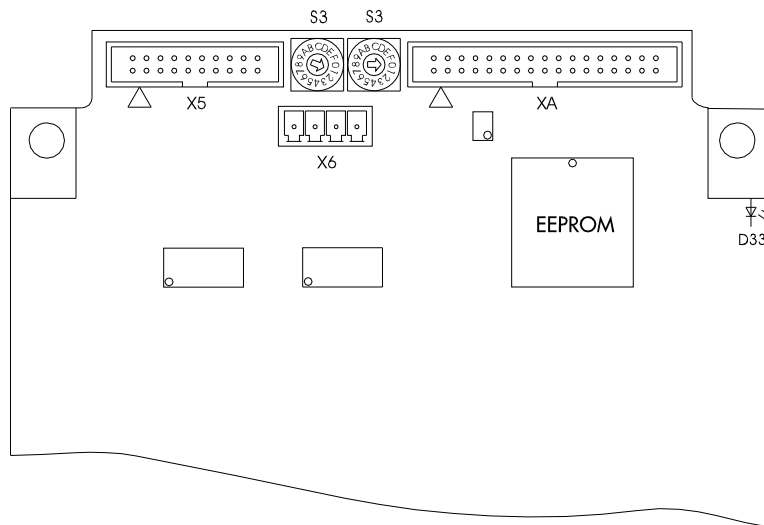





Figure 5-3. EEPROM plugs into connector X6 on the 300-SMB1 Main Board

Example: Changing the Maximum Flow, Qmax

1. The display will initially show a normal operating screen.

V	47.7	gal
Q	0.0	gal/min

2. Make sure the CAL/MEAS switch is in the CAL position.

3. Press  and then **03** to view Menu 3. Since Qmax is the first parameter displayed in Menu 3, it is not necessary to use the  or  keys to scroll to Qmax. The screen will display the current value for Qmax.

V	47.7	gal
Qmax	350.00	gal/min

4. Press the  key. The value field will be cleared, and you can enter a new value using the numeric keypad.

V	47.7	gal
Qmax	_____	gal/min













5. Press  to accept the new parameter value.

6. Press  to return to the original display.

7. Return the CAL/MEAS switch to the MEAS position.

V	47.7	gal
Q	0.0	gal/min

Table 5-1. Parameter Menu Layout

Keys	Parameter Menu Layout		Parameter mode		
			2	1	
			Locked by:		
			Unlock with Function 98 Factory Code CAL/MEAS Switch		
	Configure Measuring Register				
 00 (menu 00)		Selects which value to display during normal operation			
		Q% (percent max flow), SV (grand totalizer), V2 (second totalizer), Q (flow rate) per hour or Q per minute (see Table 5-4, Q-typ for hour/minute selection)			
	Meter Parameters				
 02 (menu 02) See table 5-2		Pipe diameter "DN"		X	X
		Unit of measure "unit"		X	
		Low Flow Suppression setpoint "LFS"	X	X	
		Operating mode of the digital outputs "output mode"	X	X	
		Number of measurements to average "average"	X	X	
		Operating mode of the analog output "currmode 4 - 20 mA"	X	X	
		Empty-pipe detection "pipe detect"	X	X	
		Disable output coils "standby mode"	X	X	
		Level of protection against parameter changes "parameter mode"		X	
	Factory setting - always 2 "out4 mode"	X	X		

Keys	Parameter Menu Layout			Parameter mode	
				2	1
					Locked by:
				Unlock with Function 98	
				Factory Code	
				CAL/MEAS Switch	
	Input / Output Parameters				
		100% flow value for analog output	"Qmax"		X
03 (menu 03) See table 5-3	▲	Determines number of pulses/unit for digital pulse output IMP1 (also applies for 2 and 3 channel pulse outputs)	"pv 1"		X
	▲	Determines number of pulses/unit for digital pulse output IMP2	"pv 2"	X	X
	▲	Maximum "on" time duration of the output pulses from outputs IMP1 - IMP2	"tp1 - tp2"	X	X
	▲	Time constant for damping analog output response	"tp3"	X	X
	▲	Minimum "on" time required for activation of inputs IN1 - IN4	"it1 - it4"	X	X
	Display Parameters				
		Selection of flow rate display (units/hour or units/minute)	"Q-Typ"	X	X
04 (menu 04) See table 5-4	▲	Number of digits to the right of the decimal point for the display of main totalizer value	"V-Format frac"		X
	▲	Number of digits to the right of the decimal point for the display of 2nd totalizer value	"V2-Format frac"	X	X
	▲	Determines whether the decimal point is displayed as a period (.) or a comma (,)	"decimal point"	X	X
	▲	Sets display unit for custody-transfer operation	"display mode"		X
	▲	Print format when using Diessel BP110 Bus Printer	"printer mode"	X	X

Keys	Parameter Menu Layout			Parameter mode		
				2	1	
				Locked by:		
				Unlock with Function 98 Factory Code CAL/MEAS Switch		
	Calibration Parameters					
		Factory calibration meter body constant - data plate	"span"		X	X
	▲	Factory calibration meter body constant - data plate	"offset"		X	X
	▲	Field calibration constant	"m spe"		X	
	▲	Field calibration constant for forward flow	"p spe"		X	
	▲	Field calibration constant for backward flow	"n spe"		X	
	▲	Compensation constant for low flow rates	"b spe"		X	
	▲	Conversion factor for user-defined flow unit (Applies only when "unit" parameter in Menu 02 is set to "free unit")	"m dim"		X	
	▲	Smallest permissible measuring amount (for certain custody transfer and trade applications)	"Vmin"		X	
	▲	3-character text input for user defined units. Appears only when "unit" parameter in Menu 02 is set to "free unit"	"free unit text"	X	X	

 05
 (menu 05)
 See table
 5-5









Keys	Parameter Menu Layout		Parameter mode	
			2	1
			Locked by:	
			Unlock with Function 98	Factory Code
			CAL/MEAS Switch	
	Review Checksums (read only cannot be altered)			
		Firmware checksum	"eprsum"	
 06 (menu 06) See table 5-6		Parameter checksum for critical calibration parameters (Parameters that cannot be unlocked by Function 98)	"eparasum"	
		Parameter checksum for non-critical parameters (Parameters that can be unlocked by Function 98)	"nparasum"	
		Meter body type	"sentyp"	
		Meter body number	"senno."	
		Shows position of CAL/MEAS switch	"switch position"	
		Display software program version	"User"	
		CS3 bus communication software version	"System SS"	
		Flowmeter measuring software version	"Appli. SA"	

Table 5-2. Meter Parameters (Menu 02)

Parameter Name	Menu 02 Meter Parameters	Remark/Range/Default
DN	Contains the pipe diameter of the transmitter	Factory setting stored in EEPROM

Parameter Name	Menu 02 Meter Parameters	Remark/Range/Default		
unit	<p>Determines the Unit of measure for the meter</p> <p>Changing the Unit of measure automatically selects the corresponding m dim value.</p> <p>If the setting free unit is chosen, no units name will be displayed on the readout. When free unit is selected, the user must enter a value for m dim.</p>	Symbol	Unit	m dim
		l	liters	1.0000
		m ³	cubicmeters	0.00100
		hl	hectoliters	0.01000
		ml	milliliters	1000.00000
		gal	U.S. gallons	0.26417
		GAL	gallons (CDN)	0.21996
		gal	Imp. gallons	0.21996
		lb	lb raw milk	0.44016
		bbl	beer barrels	0.00611
		dm ³	cubic-decimeter	1.00000
			free unit	user defined
LFS	Low Flow Suppression determines the threshold value above which the flow totalizer is active. This setting is a percentage of the full-scale flow rate Qmax	Range: Default:	0.00 - 4.00% 2.00%	
output mode	Determines the operation of the pulse outputs	Range: Default: Mode of operation:	0 - 10 1 see Table 5-7	
average	Determines the number of individual measurements required for the value calculation, i.e., determines the response time (time constant) of the display	value	time constants	application
		01	0.05 s	short filling times
		02	0.1 s	short filling times
		04	0.2 s	standard setting
		08	0.4 s	short filling times
		16	0.8 s	during varying flowing conditions
		32	1.6 s	during varying flowing conditions
currm0d 4 - 20 mA	Determines the electrical characteristics of the analog output	Range: Default:	0 - 20 mA or 4 - 20 mA 4 - 20 mA	
pipe detect	<p>Enables or disables the internal Empty Pipe Detection which suppresses erroneous flow measurement caused by a partially empty flow tube.</p> <p>Enabled → minimum conductivity 100 micromhos</p> <p>Disabled → Use count interruption at low conductivity levels! Minimum conductivity 5 micromhos</p>	Range: Default:	Pipe Detect / No Pipe Detect Pipe Detect	

Parameter Name	Menu 02 Meter Parameters	Remark/Range/Default
standby mode	<p>Reduces power consumption during metering pauses by turning off meter coil excitation current</p> <p>standby mode 0: The standby function can be activated by pressing the "F" key followed by "99" or by activating the digital input IN1</p> <p>standby mode 1: standby <u>not possible</u></p> <p>standby mode 2: standby is possible</p>	<p>Range: 0 - 2</p> <p>Default: 1</p>
parameter mode	<p>Security function for the parameters, which allows the parameters to be protected against unauthorized changes</p> <p>0 → the calibration switch "CAL/MEAS" locks only the critical calibration parameters</p> <p>1 → the "CAL/MEAS" switch locks <u>all</u> parameters</p> <p>2 → allows operator to unlock non-critical parameters by pressing the "F" key followed by "98"</p>	<p>Range: 0 - 2</p> <p>Default: 1</p>

Table 5-3. Input/Output Parameters (Menu 03)

Parameter Name	Menu 03 Input/Output Parameters	Remark/Range/Default
Qmax	Determines the scaling of the analog output (100% Qmax = 20 mA).	Range: Application specific
pv1	Determines the number of pulses per volume unit seen at output IMP1 . Value pv1 is used when several channels are available (2 or 3 channels). (see " output mode ")	Range: Application specific
pv2	Determines the number of pulses per volume unit seen at output IMP2 . Only inflow is possible at " Output-mode " 1.5	Range: Application specific
tp1 - tp3	tp1 Determines the maximum "on" time duration for the pulse output IMP1 .	Range: 0 - 32767 ms Default: 125 ms
	tp2 Determines the maximum "on" time duration for the pulse output IMP2 .	Range: 0 - 32767 ms Default: 125 ms
	tp3 Damping time constant for analog output. Analog response to step change in flowrate is 70% of actual flowrate after one time constant.	Range: 0 - 32767 ms Default: 1 s
it1 - it4	Debouncing time Minimum "on" time duration required at the corresponding digital inputs IN1 - IN4 , to recognize a valid input	Range: 0 - 32767 ms Default: 125 ms

Table 5-4. Display Parameters (Menu 04)

Parameter Name	Menu 04 Display Parameters	Remark/Range/Default
Q-Typ	Determines whether the flow rate indication is displayed in units " per Minute " or " per Hour " such as gal/h or gal/min	Range: "/min" or "/h" Default: " m " (per min)
V-Format frac	Sets the number of digits displayed to the right of the decimal point for the display of the main totalizer V	Range: 0 - 6 Default: 2
V2 Format frac	Sets the number of digits displayed to the right of the decimal point for the display of totalizer " V2 "	Range: 0 - 6 Default: 1
decimal point	Selects period (.) or comma (,) as the display symbol for the decimal point	Range: (,) or (.) Default: (.)
display mode	Determines whether the display unit is to be additionally checked (for trade use) 0 → For non-officially-approved systems: A. Error message reset automatically B. Zeroing of totalizers V and V2 at available flow (Q≠0) is enabled 1 → For officially approved systems: Display used as Main Counter in officially approved system	Range: 0 - 1 Default: 0
printer mode	Determines printed output format when using Diessel BP110 Bus Printer. 1 → No printer 2 → Printout without sequential number 3 → Printout with sequential number	Range: 1 - 3 Default: 1

Table 5-5. Calibration Parameters (Menu 05)

Parameter Name	Menu 05 Calibration Parameters	Remark/Range/Default
span	Factory calibration value of the meter body	Factory setting stored in EEPROM
offset	Factory calibration value of the meter body	Factory setting stored in EEPROM
m spe	Field calibration factor: Factor serves to adjust the possible measuring deviations in the complete system	<ol style="list-style-type: none"> 1. At time of shipment, the factor is always set to 1.0000 2. During <u>positive</u> measuring deviations, factor is set to m spe < 1 during <u>negative</u> measuring deviations, factor is set at m spe > 1 3. m spe = 0 is not accepted
p spe	Separate Evaluation Factor for the <u>positive</u> flow	Range: p spe = 0 is not accepted Default: 1.00000
n spe	Separate Evaluation Factor for the <u>negative</u> flow	Range: n spe = 0 suppresses measurement during reverse flow Default: 0.00000
b spe	Field calibration factor: Factor serves to adjust possible measuring deviations in the complete system for <u>lower flow rates</u>	Range: Default: 0.00000
m dim	Dimension factor for the user-defined unit of measurement. Can be changed only if the setting " free unit " in the parameter type " unit " was previously selected.	Range: m dim = 0 will <u>not</u> be accepted Default: Dependent on units selection
Vmin	Smallest permissible measuring amount	Depends on the application. Only used in legal-for-trade or certified measuring system.
free unit text	Appears only when "unit" parameter in Menu 02 is set to "free unit". Allows user to input 3-character unit designation for visual display.	User defined.

Table 5-6. Review Checksums (Menu 06)

Parameter Name	Menu 06 Review Checksums	Remark
eprsum	Display of checksum of the firmware program	Read-only value is based on the program version
eparasum	Display of checksum for the critical calibration parameters. (Parameters that cannot be unlocked by Function 98.)	Read-only value is based on the adjusted parameter data
nparasum	Display of checksum for non-critical parameters. (Parameters that can be unlocked by Function 98.)	Read-only value is based on the adjusted parameter data
sentype	Display of meter body type	Read-only value
senno.	Display of meter body number	Read-only value
switch position		Shows position of CAL/MEAS switch
user	Display software version	Read-only value
System 55	CS3 bus communication software version	Read-only value
Appli 5A	Flow measuring software version	Read-only value

Table 5-7. Output Mode Configuration Settings

Output Mode	Output	Output Diagram	Maximum Frequency	Pulse Length or Pulse / Pause Ratio	Direction of Flow	Scaling parameter	Remarks/Application
1	IMP1		500 Hz	Max. pulse on-time duration programmable in msec via tp1 and tp2. Off-time is remainder of cycle. Set tp _x = 0 for pulse / pause ratio = 1 : 1 for IMP _x	Both	pv1	Outputs IMP1 and IMP2 pulse independently using scaling parameters pv1 and pv2 respectively. Outputs pulse without regard to flow direction.
	IMP2					pv2	
	IMP3					Digital control signal	
2	IMP1		500 Hz	Pulse / Pause Ratio = 1 : 1	Both	pv1	Outputs IMP1 and IMP2 offset 180° at output rate determined by scaling parameter pv1. IMP2 switches off in case of error.
	IMP2						Energized during positive flow
	IMP3						Digital control signal
3	IMP1		500 Hz	Max. pulse on-time duration programmable in msec via TP1. Off-time depends on scaling and flow rate. Set TP1 = 0 for pulse / pause ratio = 1 : 1	Both	pv1	Used for keg-filling operations. One or two stage quantity pre-selection in positive flow direction. When pv1 = 0 IMP1 is energized during error.
	IMP2						Furnishes pre-signal for 2-stage filling
	IMP3						Furnishes final signal for one- or two-stage filling
4	IMP1		500 Hz	Pulse on-time duration fixed at 1 msec. Off-time depends on scaling and flow rate.	Both	pv1	Outputs IMP1 and IMP2 offset 90° at output rate determined by scaling parameter pv1. IMP2 switches off in case of error.
	IMP2					pv2	
	IMP3					Digital control signal	
5	IMP1		500 Hz	Max. pulse on-time duration programmable in msec via tp1 and tp2. Off-time depends on scaling and flow rate. Set tp _x = 0 for pulse / pause ratio = 1 : 1 for IMP _x	Both	pv1	Same function as Output Mode 1, except output IMP 1 pulses only during forward flow and output IMP2 pulses only during reverse flow.
	IMP2					pv2	
	IMP3					Digital control signal	
6	IMP1		166 Hz	Pulse / pause ratio = 1 : 1	Both	pv1	Outputs IMP1, IMP2, and IMP3 offset 120° at output rate determined by scaling parameter pv1. IMP2 switches off in case of error.
	IMP2						
	IMP3						
7	IMP1		500 Hz	Max. pulse on-time duration programmable in msec via tp1 and tp2. Off-time depends on scaling and flow rate. Set tp _x = 0 for pulse / pause ratio = 1 : 1 for IMP _x	Both	pv1	Same function as Output Mode 5, except output IMP 3 functions as an error signal rather than a flow direction flag.
	IMP2					pv2	
	IMP3					Digital control signal	
8	IMP1		500 Hz	Pulse / pause ratio = 1 : 1	Forward	pv1	Same function as Output Mode 2 with storage and suppression of up to 16,000 reverse pulses. IMP2 switches off in case of error.
	IMP2						
	IMP3						Digital control signal
9	IMP1		1000 Hz	Max. pulse on-time duration fixed at 50 µsec. Off-time depends on scaling and flow rate.	Forward	pv1	Same function as Output Mode 1 but with a maximum output frequency of 1000 Hz
	IMP2			Max. pulse on-time duration programmable in msec via TP2. Off-time depends on scaling and flow rate. Set TP2 = 0 for pulse / pause ratio = 1 : 1		pv2	
10	IMP1		500 Hz	Pulse on-time duration fixed at 1 msec. Off-time depends on scaling and flow rate.	Forward	pv1	Up to 16,384 reverse pulses are stored temporarily
	IMP2			Max. pulse on-time duration programmable in msec via TP2. Off-time depends on scaling and flow rate. Set TP2 = 0 for pulse / pause ratio = 1 : 1		pv2	

Appendix A

Troubleshooting

This appendix will help to identify and correct some of the common problems encountered when installing or operating the IZMSG Compact Flowmeter.

Many problems are caused when making electrical connections. Refer to Section 3 and make sure that the connection cables are properly and securely installed. Check the installation diagrams. Test the connection of each wire by gently tugging the wire with needle nose pliers to ensure that the wire is fully engaged in its terminal. Make sure that AC power is available to the converter and that the jumpers on the power supply board are configured for the voltage supply provided.

The appendix provides:

- information on troubleshooting the converter
- information on troubleshooting the meter body
- procedure for performing a Dry Meter Body Resistance Check
- information on Zero Test troubleshooting
- error diagnosis with LCD display
- hardware test sequence

Converter

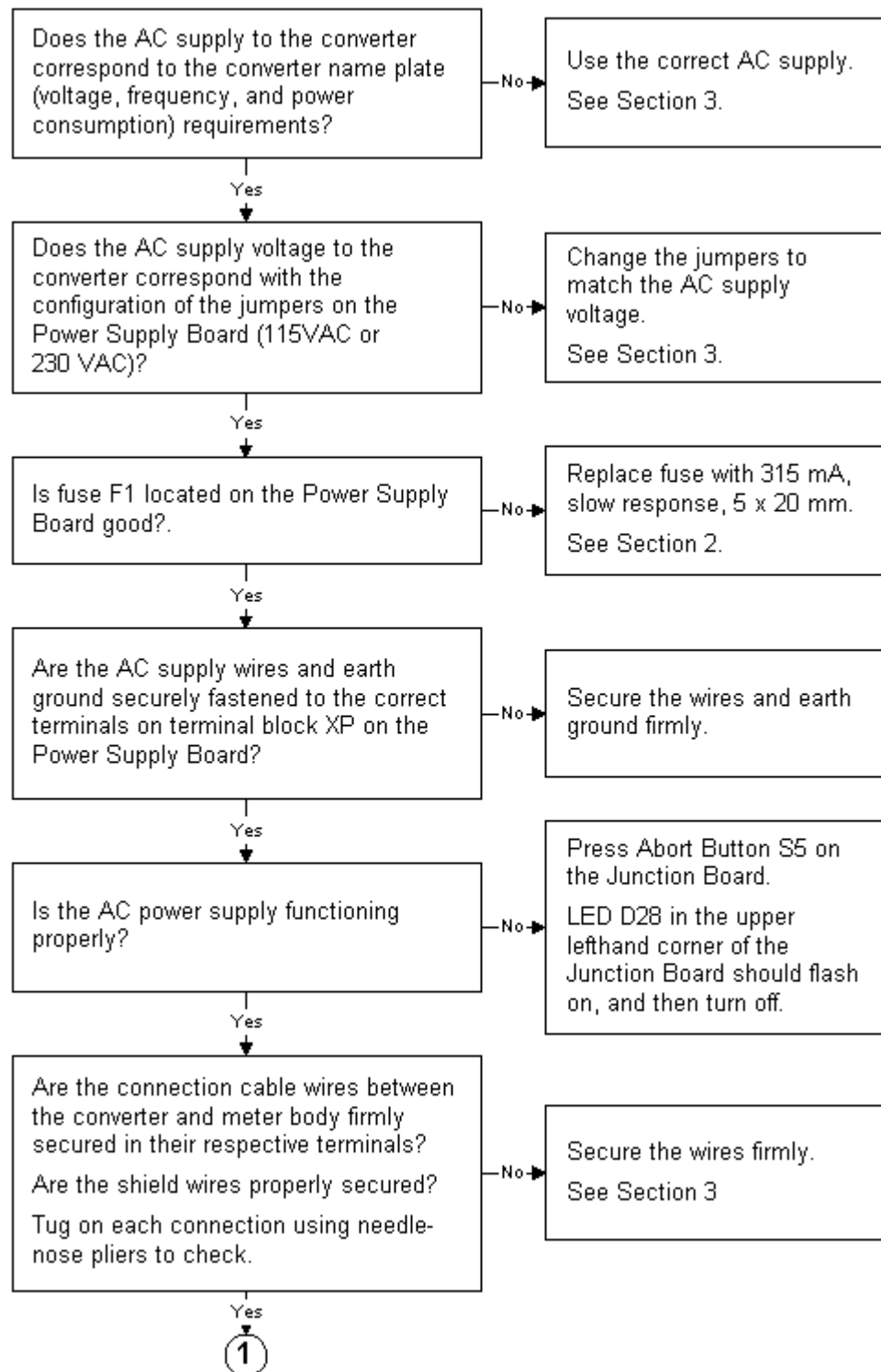

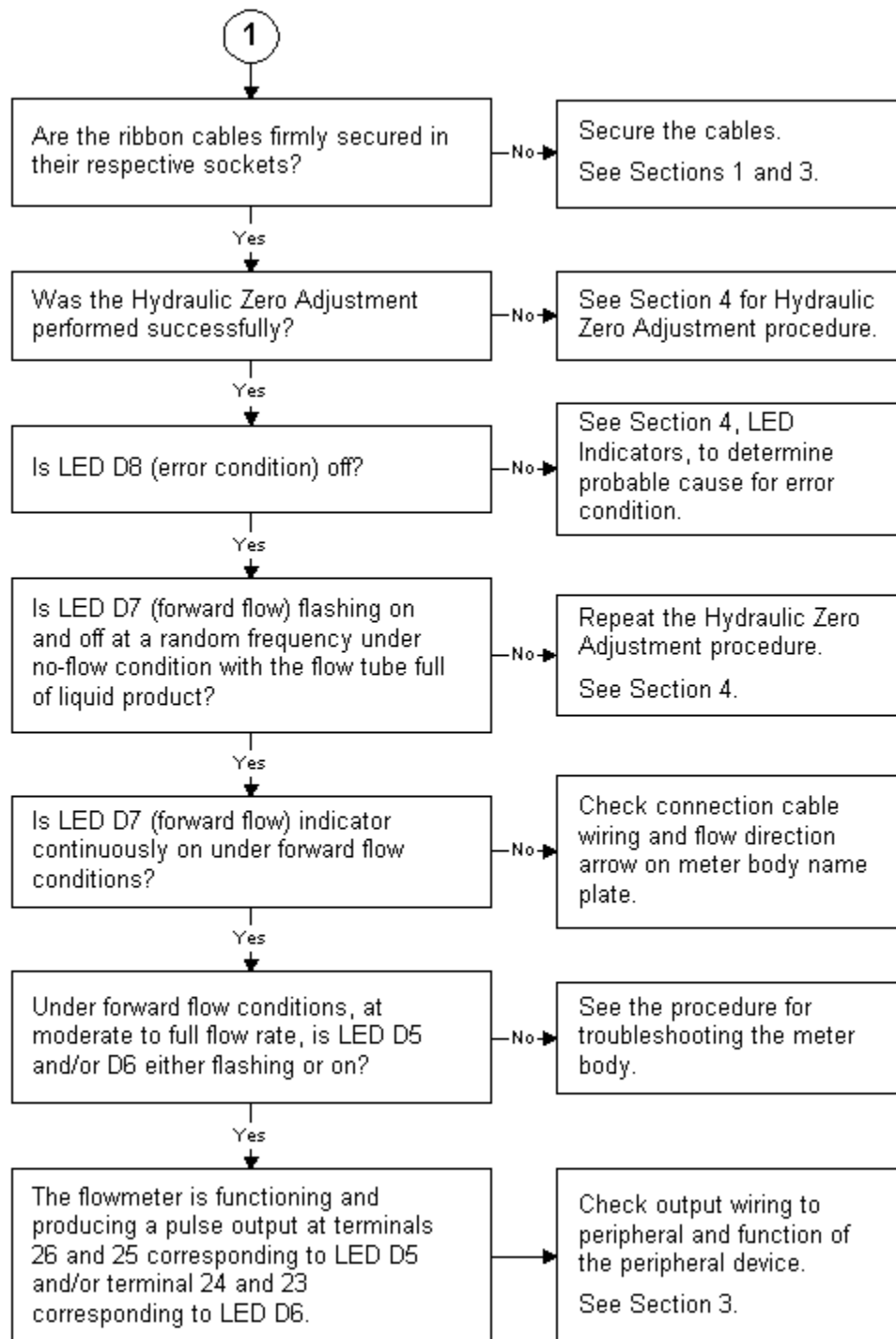

Meter Body

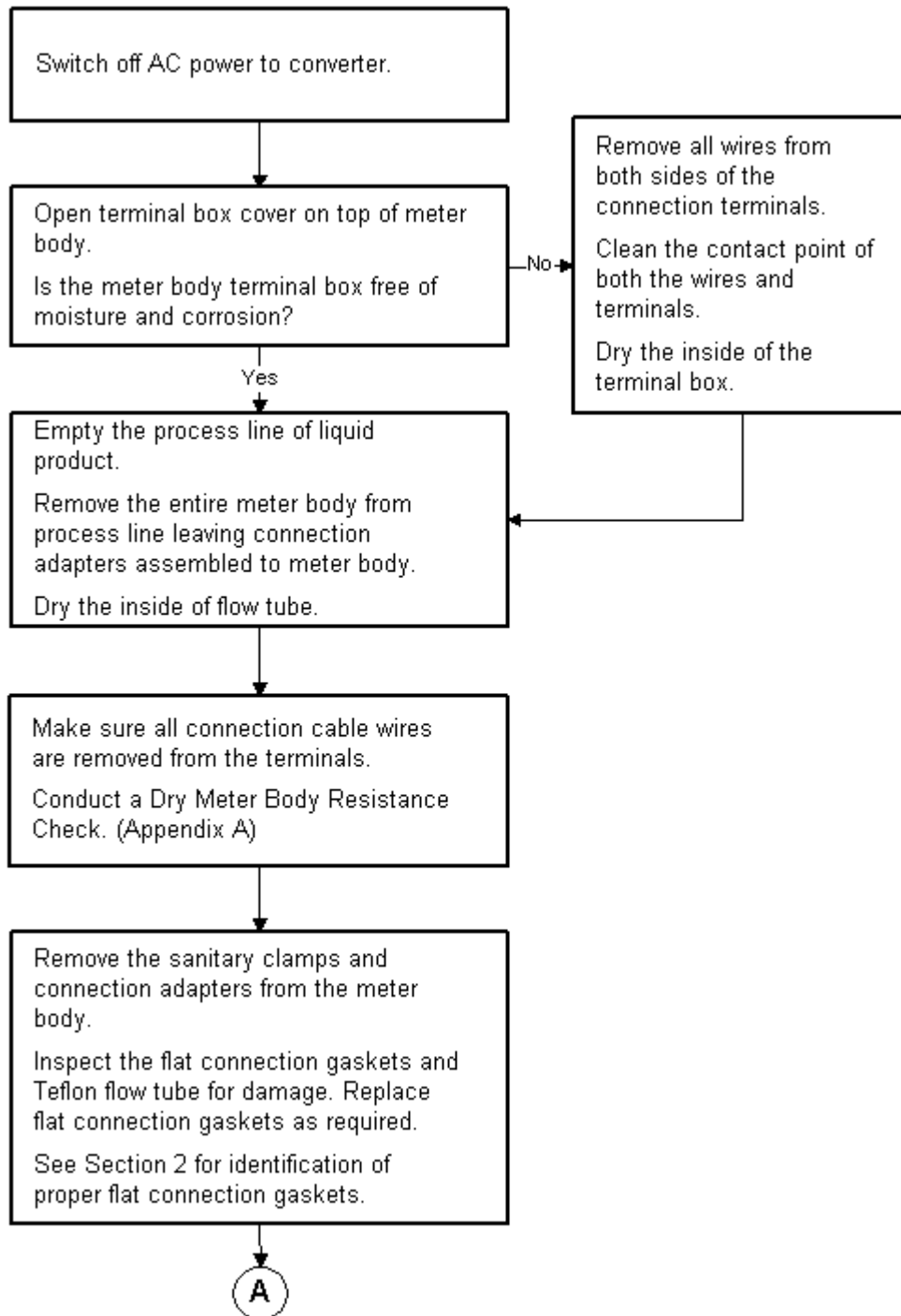

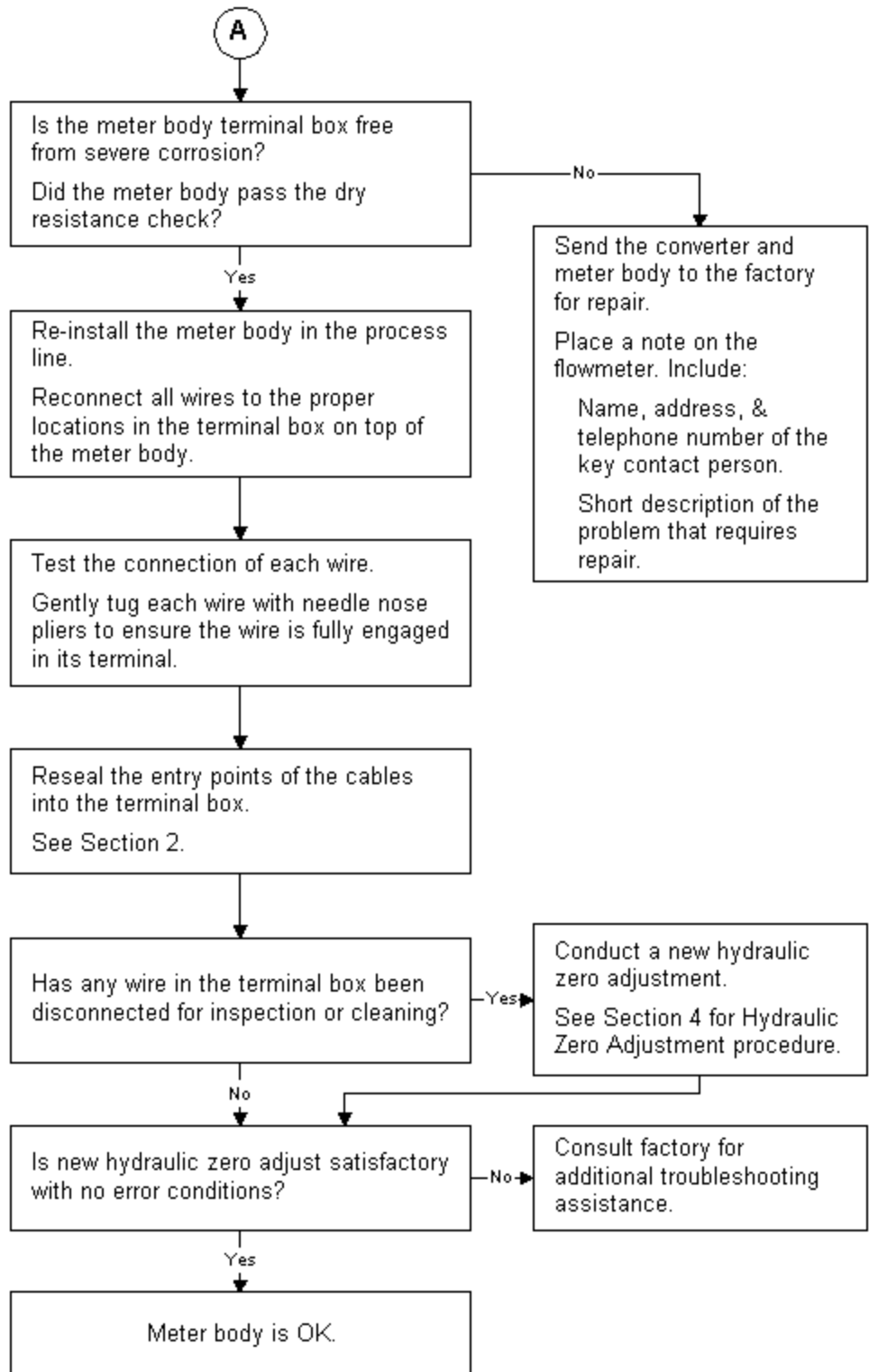

Dry Meter Body Resistance Check

To conduct a dry meter body resistance check:

1. Switch off the AC power to the converter.
2. Empty the flow tube completely. Dry the inside of the flow tube.
3. Disconnect the coil drive cable wires from terminals 11 and 12 in the meter body terminal box.
4. Disconnect the electrode signal cable wires from terminal 13, 18, 14, and 16 in the meter body terminal box.

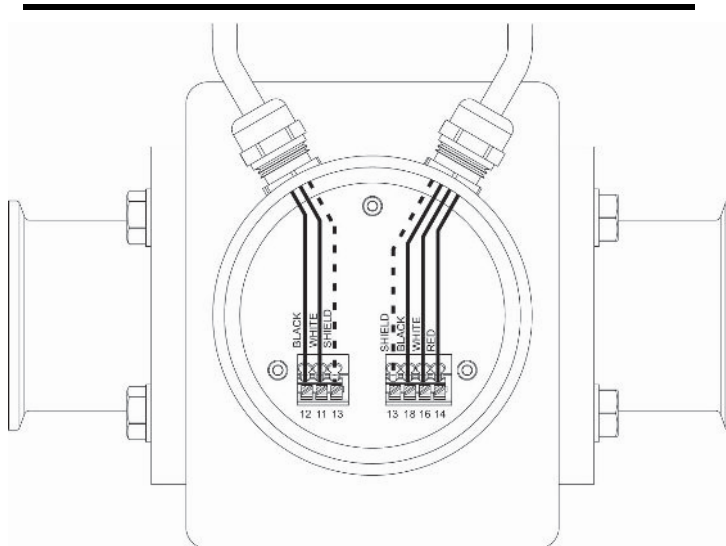

Figure A-1. Meter Body Terminal Box

5. Use a multimeter to measure resistance at 5 points (see Figure A-2 and the accompanying table).

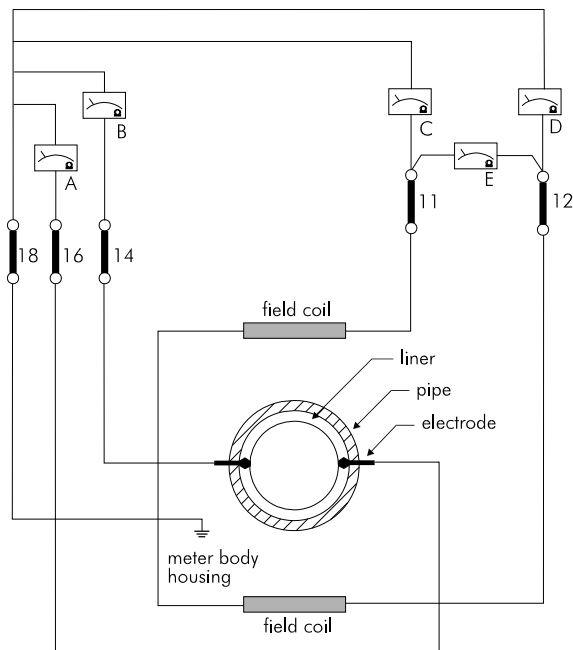

Figure A-2. Dry Meter Body Resistance Check Points

Position	Resistance Between Terminals	Measured Resistance for Functional Meter Body
A	16 and 18	> 20M ohms
B	14 and 18	> 20M ohms
C	11 and 18	> 20M ohms
D	12 and 18	> 20M ohms
E	11 and 12	70 to 120 ohms

Where: > means greater than; M means million

6. If the meter body fails to meet any of the measured resistance values in the table above, the meter body and the converter must be sent to the factory for repair. Place a note on the flowmeter with the name, address, and telephone number of the key contact person. Include a short description of the problem that requires repair.

Zero Test Troubleshooting

(Converter with LCD Display or using MSD Service Display)

Zero Test values can be useful for troubleshooting a flowmeter problem or revealing a hidden condition that may have an adverse effect on flowmeter performance. See Section 4, *Start-Up and Commissioning*, for the procedure to conduct a Zero Test.

Comparing Zero Adjust and Zero Test Values

The zero value stored in the converter memory may be displayed by entering Menu 70. See Section 5, *Using the LCD Display*, for use of the keypad menu functions.

The stored zero value is the result of the last Zero Adjust conducted on the flowmeter which probably occurred when the flowmeter was installed. Assuming that the original installation conditions have not changed, there should be no substantial difference between the current Zero Test value and the original stored Zero Adjust value.

If there is a gross difference of 75 to 100 units or more between the current Zero Test measurement and the stored Zero Adjust value, then there is a strong possibility that a problem exists. Check the connection cable wiring for loose connections and for corrosion in the meter body terminal box. Conduct a Dry Meter Body Resistance Check to determine if there has been an insulation breakdown due to internal contamination of the meter body.

Repeating Zero Test Measurement

When conducting several Zero Tests in succession under identical conditions, the repeated zero measurements should be within ± 2 units. The inability to achieve uniformity of results from repeated Zero Test measurements indicates a problem in connection cable wiring, corrosion of the connection cable terminations, or meter body insulation breakdown due to internal contamination. Refer to the Dry Meter Body Resistance Check.

Error Diagnosis with LCD Display

The IZMSG converter is equipped with a self-monitoring system that automatically senses error conditions and displays a flashing message on the first line of the LCD display to alert the operator to the condition.

Depending on the setting of the parameter Display Mode (see Section 5, *Using the LCD Display*), the error message can be acknowledged and deleted by pressing the ZERO key . If the condition causing the error persists, the error message will return immediately.

Note: Pressing the ZERO key will also reset the main totalizer *V*.

Certain error messages will be deleted automatically if the condition causing the error is corrected.

Error Message Number	Error Diagnosis	Corrective Action
901	a) AC power failure or AC voltage outside operational range. b) Parameter was changed during measuring. c) Digital input IN1 was actuated during measuring. d) Abort (reset) pushbutton was pressed.	Delete error message by pressing the ZERO key.
903	A/D converter overflow.	a) Air in flow tube. Fill flow tube with liquid. b) Flowrate too high. Reduce flowrate. Consult factory for proper flowmeter sizing. c) Electronic malfunction.
905	Disturbance caused by EMI or RFI interference in the surrounding environment.	Eliminate source of interference. Delete error by pressing ZERO key.
922	Defective amplifier in converter.	Consult factory.

Error Message Number	Error Diagnosis	Corrective Action
923	Short-term deviation of the amplifier in the converter.	a) Delete error message by pressing ZERO key. b) AC power down and then power up. c) Check terminals 11 and 12 at both the meter body and converter. d) Check coil resistance at the meter body. e) Consult factory.
924	Permanent failure of the amplifier in the converter.	Consult factory.
928	Coil drive current to meter body is outside operational range.	Consult factory.
932	No coil drive current to the meter body. Visual display message “no current”.	a) Check terminals 11 and 12 at both meter body and converter. b) Make sure all connections are fully engaged, clean, and dry. c) Check resistance of meter body coils between terminals 11 and 12 (see Meter Body Dry Resistance Check, Appendix A).
3050	Qmax value too large.	Reduce value of Qmax (Menu 03). Consult factory for proper flowmeter sizing.
3063	Pulse value pv1 set too high.	Reduce pulse value pv1.
3064	Pulse value pv2 set too high.	Reduce pulse value pv2.
3070	Factory meter body parameter “span” set to 0.	Consult factory.

Error Message Number	Error Diagnosis	Corrective Action
3083	Hydraulic zero measurement out of range.	<p>a) Recheck all conditions required for hydraulic zero adjustment:</p> <ol style="list-style-type: none"> 1) All connection cable terminations are tight, dry, and in correct locations. 2) Flow tube is full of product. 3) No flow or leakage. <p>Conduct hydraulic zero adjustment again. (See Section 4, Hydraulic Zero Adjustment.)</p> <p>b) Check grounding of meter body (see Section 3).</p> <p>c) Conduct Dry Meter Body Resistance Check (see Appendix A).</p>

Hardware Test Sequence

The hardware test sequence is used to test both the inputs and outputs of the IZMSG flowmeter and the connected peripheral devices.

Press the keys F ⑧ ③ ⑨ to activate the hardware test sequence.

WARNING!

Make certain the process that the flowmeter is controlling is closed off or disconnected before activating the hardware test sequence.

2 nd line of the display		Function		LED Indicator									
				D11	D14	D17	D20	D5	D6	D7	D8		
	all outputs off	the digital outputs are switched off						o	o	o	o		
	OUT1 On	only output IMP1 is active - on						x	o	o	o		
▲	OUT2 On	only output IMP2 is active - on						o	x	o	o		
	OUT3 On	only output IMP3 is active - on						o	o	x	o		
	OUT4 On	only output OUT4 is active - on						o	o	o	x		
▲	Anaout 4 mA	4 mA are at terminal X8 #5/#6											
	Anaout 20 mA	20 mA are at terminal X8 #5/#6											
	IN1=0 IN2=0 IN3=0 IN4=0	no input is activated		o	o	o	o	o	o	o	o	o	o
	IN1=1 IN2=0 IN3=0 IN4=0	only input IN1 is activated		x	o	o	o	o	o	o	o	o	o
▲	IN1=0 IN2=1 IN3=0 IN4=0	only input IN2 is activated		o	x	o	o	o	o	o	o	o	o
	IN1=0 IN2=0 IN3=1 IN4=0	only input IN3 is activated		o	o	x	o	o	o	o	o	o	o
	IN1=0 IN2=0 IN3=0 IN4=1	only input IN4 is activated		o	o	o	x	o	o	o	o	o	o

2 nd line of the display	Function	D11	D14	D17	D20	D5	D6	D7	D8
Curr1 on	coil current is constantly at app. +100 ... 110 mA metered at terminal #11/#12								
Curr2 on	value of the metered coil current must be almost the same as "Curr1 on" (± 0.3 mA) but with the reverse polarity								
end hardware test Quit with key ENTER	use the key  to end this function								

x = LED on
o = LED off

Appendix B

Theory of Operation

The Anderson IZMSG Electromagnetic Flowmeter is a precision instrument for volumetric measurement of electrically conductive fluids. The flowmeter operates on the principle of electrical induction known as Faraday's Law.

Faraday's Law of Induction was proposed in the 1820's by Michael Faraday, an English physicist. He experimented with magnets and found that if a conductor moves through a magnetic field, a voltage is induced in the conductor. Applied to the flowmeter, a conductive fluid in the flow tube moves through a magnetic field and a voltage is induced in the electrodes (see Figure B-1).

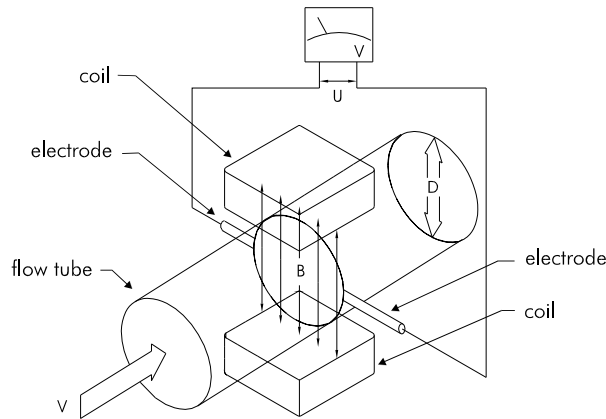

Figure B-1. Faraday's Law

Faraday's Law can be expressed mathematically as follows:

$$U = K \times B \times V \times D$$

where: U = induced voltage
K = proportionality constant
B = magnetic field strength
V = average flow velocity
D = distance between the electrodes (flow tube diameter)

If the flow tube (pipe) diameter and the magnetic field are constant, the equation reduces to:

$$U = G_k \times V$$

where: G_k = device constant
 V = average flow velocity

This means that the induced voltage or signal sensed in the meter body and transmitted to the converter is directly proportional to the flow velocity. The signal is independent of the fluid properties and operating characteristics such as product density, viscosity, conductivity, consistency, pressure, and temperature.

The device constant, G_k , is determined by factory calibration. The magnetic field is controlled by a regulated, load independent DC current supply. The supply is switched so that it remains constant for two full cycles of the power supply frequency.

Appendix C

IZMSG Technical Specifications

Meter Body

Connections	Sanitary clamp type
Construction	<i>Housing:</i> AISI Type 304 Stainless Steel <i>Lining:</i> PTFE (Non-filled virgin Teflon) <i>Electrodes:</i> AISI Type 316L Stainless Steel <i>Connection Box:</i> Cast aluminum with SBGL corrosion resistant coating
Entry Wiring Connections	Choice of: 2 water tight cord grips 2 female ½" NPT conduit adapters
Maximum Product Temperature	325°F (160°C)
Maximum Inlet Pressure	154 psi absolute (11 bar)
Minimum Inlet Pressure	1.4 psi absolute (0.1 bar)
Minimum Fluid Conductivity	<i>Standard:</i> 100 micromhoes/cm <i>Special Request:</i> 5 micromhoes/cm
Magnetic Field	DC pulsed @ 20 Hz with constant current supply Self correcting zero adjust

Converter

Power Supply	Field selectable by jumpers: 115 VAC/50-60 Hz/single phase 230 VAC/50-60 Hz/single phase
Power Requirements	15 VA (approximately 8 W)
Fuse Protection	315mA, slow response, 5 x 20mm
Scaled Digital Outputs	2 independent, scalable pulsed outputs Open collector 30 V @ 20 mA Opto-isolated

Scaling	Independent scaling for 2 pulsed outputs from 0.00001 to 10,000 pulses/volumetric unit
Output Pulse Frequency and Width	<i>Standard Configuration:</i> 1:1 pulse to pause ratio 500 Hz maximum <i>Adjustable:</i> 1 - 60,000 msec; 500 Hz maximum <i>Fixed:</i> 50 micro-sec pulse width; 1000 Hz maximum
Output Pulse Signals	Selectable from following: 2 independent 2 channel by 90° shift 2 channel by 180° shift 3 channel by 120° shift 1 forward flow, 1 reverse flow
Output Control Signals	<i>Open collector:</i> 30 V @ 20 mA <i>Selectable:</i> Forward flow or Error signal
Analog Output	<i>Selectable:</i> 4-20 mA or 0-20 mA <i>Adjustable Averaging:</i> 0.1 to 2.5 seconds <i>Adjustable Damping:</i> 0 to 60 seconds <i>Maximum Resistive Load:</i> 500 ohms
Remote Inputs	Four discrete inputs: 1 - suspend measuring with coil power supply off 1 - remote reset internal totalizer with error reset 2 - unassigned Opto-isolated 10-30V input into 3K ohm internal resistor 1 msec minimum pulse width with adjustable debounce
LED Indicators	Pulse Output 1 Pulse Output 2 Forward Flow Error Condition
Rezero Feature	Pushbutton for automatic hydraulic zero of flow tube during field installation
Serial Communication	RS485 Serial Interface Control System 3 - Bus Protocol 57,600 Baud
Internal Display and Keypad (D-Option)	Two line, 20 digit alphanumeric backlit LCD display for displaying product totals, flow rates, programming parameters, and error messages 25-key membrane keypad
Connection Cables Supplied (Set of two)	<i>Coil Drive Cable:</i> 2-conductor, 18 AWG shielded signal cable with drain wire <i>Electrode Signal Cable:</i> 3-conductor, 16 AWG shielded signal cable with drain wire <i>Note:</i> 25 feet supplied as standard with factory prepared ends. Consult factory for longer lengths.

Operating Temperature	-13°F to 130°F (-25°C to 55°C)
Converter Construction	Cast aluminum with SBGL corrosion resistant coating
Entry Wiring Connections	5 water tight cord grips 4 female ½" NPT conduit adapters

FLOW RANGES

Size	Operational Flow Range	
	gal/min	ltr/min
15	0.3 - 30	1.17 - 11.7
25	0.8 - 80	3.0 - 300
32	1.3 - 130	5.0 - 500
50	3 - 300	11.7 - 1166
65	5.2 - 525	20 - 2000
80	8 - 800	30 - 3000
100	12 - 1200	46 - 4667

Accuracy ±.20% of rate ± 1 mm/sec



Anderson Instrument Co., Inc.
156 Auriesville Rd.
Fultonville, NY 12072

Phone: 518-922-5315 or 800-833-0081
Fax: 518-922-8997 or 800-726-6733

Technical Bulletin

IZMSG HART Installation Kit Part# 56705A0001

SPECIFICATIONS

Communication:	Hart version 6
Loop Power (excitation):	24 vdc
Output:	4-20mA dc, 2-wire
Loop Resistance:	500 ohms (max) at 24 vdc
Cable Recommended:	2 conductor; stranded, 18-24 AWG, shielded with ground

INSTALLATION

Hart board hardware for installation to an IZMSG flowmeter



Qty: 4 – M3 x 10mm standoffs
(Included in kit)

- 1.) Remove the X9 terminal block from the Junction board indicated to the right.
- 2.) Remove the 4 indicated screws holding the Junction board to the Main circuit board (see manual AIC2040 page 1-5, Figure 1-5).
- 3.) Place the screws and washers to the side for reuse when installing the Hart board.
- 4.) Install M3 x 10mm standoffs to the 4 Hart mount location indicated on the Junction circuit board positions indicated to the right.
- 5.) Fasten the Hart board to the Junction board using the screws removed in step 2.
- 6.) Connect prewired CS3-BUS connector to corresponding X9 socket located on the Junction board.

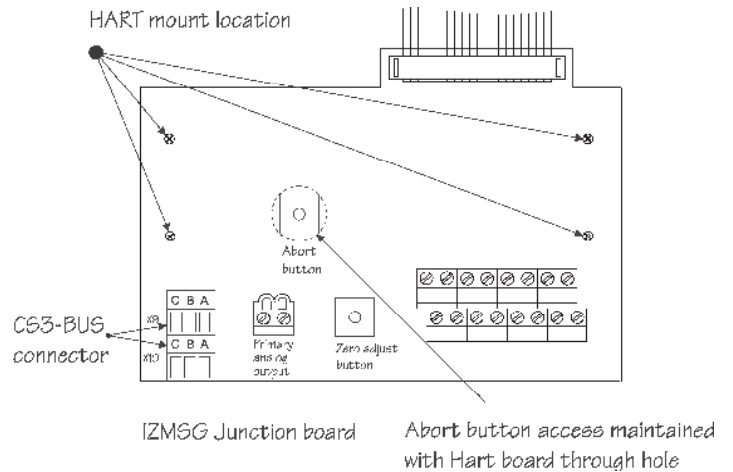

Zero Trim

- 1.) Apply loop power to the Hart transmitter board after applying power to the IZMSG converter.
- 2.) Connect the Hart communication device across the transmitter terminals. The signal loop must have at least 250 ohms resistance for Hart communication device function.
- 3.) Turn on the Hart communication device. Wait until communications are established and the Home Menu is displayed.
- 4.) If the Process Value is not within specification after stabilization:
 1. Select Calibration
 2. Select D/A trim
 3. Select "OK" to acknowledge WARN-LOOP remove from auto control
 4. Select "OK" to acknowledge connection of mA indicator
 5. Select "OK" to acknowledge setting field deviation output to 4mA.
 6. Enter indicated mA value and acknowledge with selecting "OK"
 7. Acknowledge indicated mA adjustment with "YES/NO" then select "OK"
 8. Select "OK" to acknowledge setting field deviation output to 20mA.
 9. Enter indicated mA value and acknowledge with selecting "OK"
 10. Acknowledge indicated mA adjustment with "YES/NO" then select "OK"
 11. Select "OK" to acknowledge loop returning to original output
 12. Select "OK" to acknowledge NOTE return to auto control

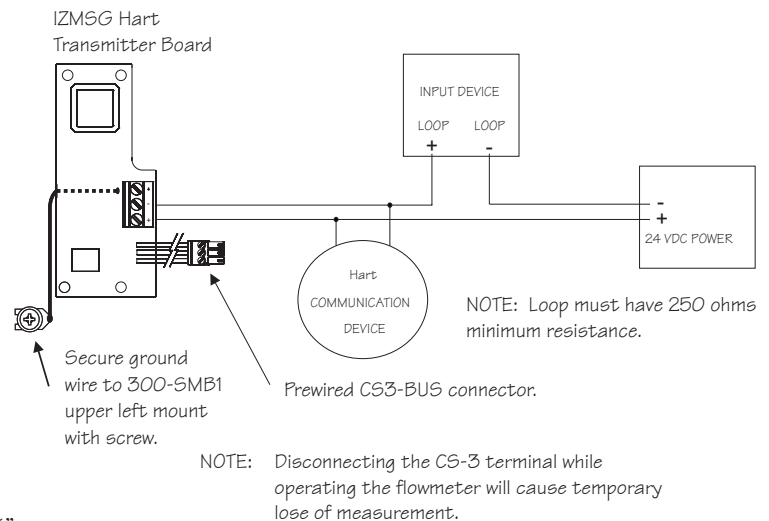

NOTE: Hart output will fault at 3.85mA with loss of IZMSG signal.

IZM HART Flowchart

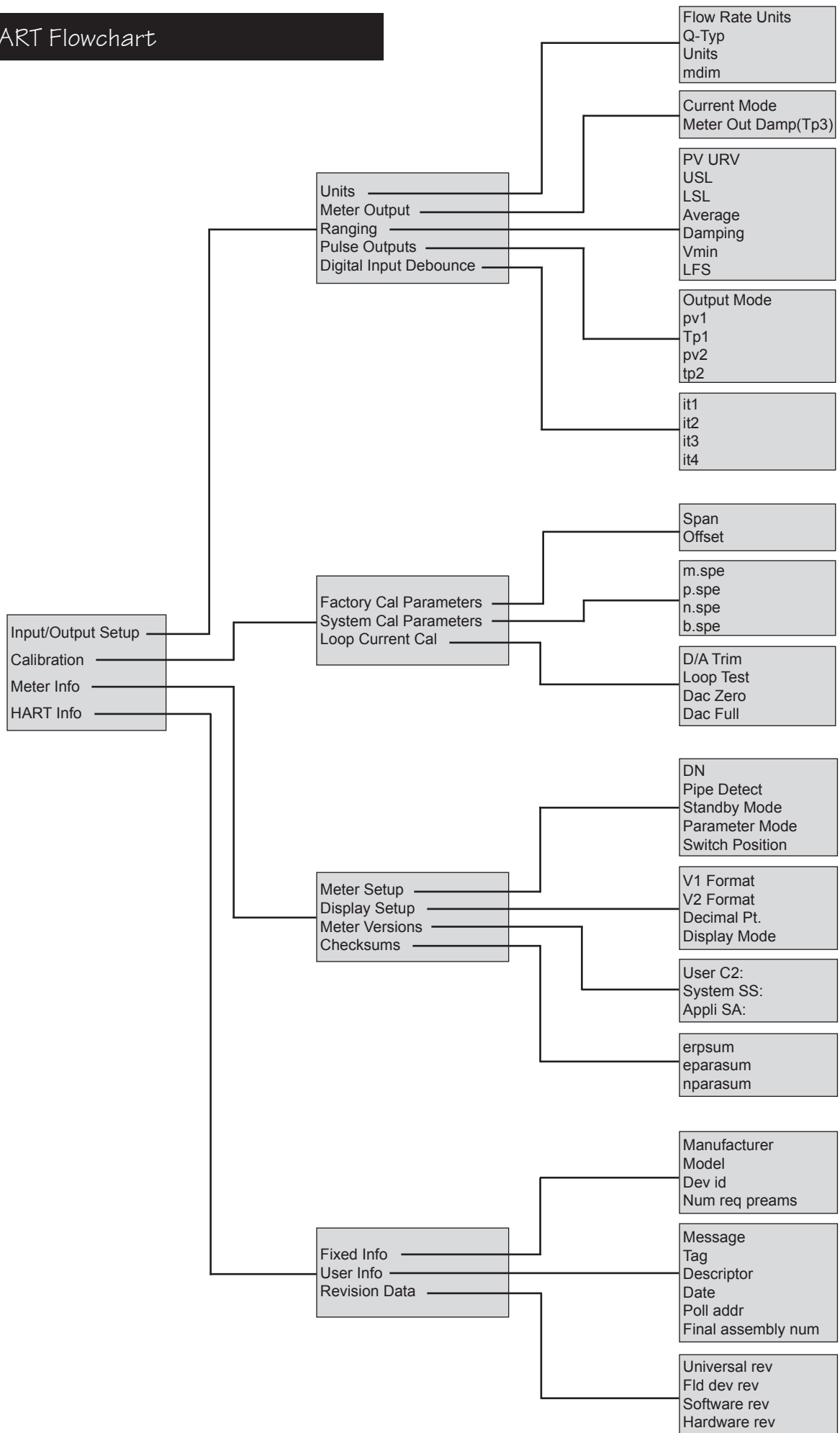



ANDERSON INSTRUMENT CO., INC • 156 AURIESVILLE RD. • FULTONVILLE, NY 12072 • USA • 800-833-0081 • FAX 518-922-8997
ANDERSON INSTRUMENT CO. LP • 400 BRITANNIA RD. EAST, UNIT 1 • MISSISSAUGA, ONTARIO L4Z 1X9 • CANADA • 905-568-1440 • FAX 905-568-1652
NEGELE MESSTECHNIK GmbH (A Division of Anderson) • RAIFFEISENWEG 7 • D-87743 EGG A. D. GÜNZ • GERMANY • +49 (0) 8333/9204-0 • FAX +49 (0) 8333/9204-49

www.andinst.com